



FAVS
Scientific Equipment
di Gnudi Andrea e Antonella S.r.l.
Tel. 051501153
www.favs.it • info@favs.it

Syringes for the laboratory



Trajan Scientific and Medical (Trajan) offer a comprehensive range of syringes that deliver precision and accuracy in analysis and ensure the integrity of analytical samples.

We combine precision manufacturing of components and meticulous assembly, to produce syringes of the highest quality.

SGE® syringes have been a recognized syringe choice in analytical laboratories for over 50 years. They combine precision manufacturing and meticulous assembly for precise volume delivery.

L-MARK® Gold and L-MARK syringes are designed and tested for optimum performance of LC instruments. L-MARK Gold syringes feature a chemically inert needle for extremely low system carryover.

Our comprehensive expertise in liquid handling technologies enables us to develop syringes for a wide range of applications.



Contents

Structure of a syringe	2
Syringe selection	3
Syringe care and maintenance	6
GC autosampler syringes	8
SGE GC autosampler syringes Agilent	8
SGE GC autosampler syringes CTC Analytics	9
SGE GC autosampler syringes PerkinElmer	11
SGE GC autosampler syringes Scion Instruments	11
SGE GC autosampler syringes Shimadzu	12
SGE GC autosampler syringes Thermo Scientific	13
LC autosampler syringes	15
L-MARK LC autosampler syringes CTC Analytics	15
SGE LC autosampler syringes PerkinElmer	18
SGE LC autosampler syringes Waters	18
LC manual syringes	19
SGE LC manual syringes Rheodyne and Valco	19
Syringes for manual applications	20
SGE syringes NanoVolume	20
SGE syringes Manual	22
SGE syringes Luer Lock and Luer Tip	24
Hamilton cross reference	26
eVol xr syringes and accessories	34

Structure of a syringe

Syringe type

See page 3

A comprehensive range of syringes is available for both autosampler and manual use

Termination

See page 4

The interface between the syringe barrel and the needle

Needle type

See page 5

Needle tip styles are available to suit a range of applications and uses

Syringe volume

See page 4

Selection of syringe volume for the best possible reproducibility and accuracy

Plunger type

See page 5

Plunger types are available to suit a range of applications and uses



Which syringe to use?

Trajan offers a complete range of syringes with a range of capacities, termination types and needle styles to suit almost any application.

What type of syringe?

If the syringe is being used by hand, a manual syringe is selected. If the syringe is being installed in an instrument then select an autosampler syringe to suit that particular instrument. Trajan's extensive range of autosampler syringes are designed to meet all fit, form and function criteria of a specific autosampler model. They meet dimensional specifications and have accuracy $\geq \pm 1\%$.



The following syringe types are offered:

Syringe type	Page(s)
GC autosampler syringes	8-14
LC autosampler syringes	15-19
NanoVolume syringes	20-21
Manual syringes	22-23
Luer Lock and Luer Tip syringes	24-25
Syringes with valves	23
Syringes with repeating adaptor	21

Syringe volume

For the best possible injection reproducibility and accuracy, the smallest injectable volume from any syringe should be no less than 10% of its total capacity. For example, the smallest recommended injection volume from a 10 μL syringe would be 1 μL .

To accurately dispense less than 1 μL a NanoVolume syringe is recommended. SGE NanoVolume syringes are available with capacities ranging from 0.5 μL to 5 μL . These syringes can inject volumes as low as 0.05 μL because the entire sample is contained within the needle. Designed with submicron tolerances, they provide precision and accuracy of $\pm 2\%$.





Trajan's extensive range of autosampler syringes meet all fit, form and function criteria of a specific autosampler model. SGE GC autosampler syringes are color coded according to syringe volume, enabling easy identification of syringes installed in instruments.

Color	Syringe volumes		
Light orange	0.5 μL	500 μL	
Yellow	1 μL		1 mL
Lime	5 μL		5 mL
Dark orange		10 μL	10 mL
Green		25 μL	
Purple		50 μL	
Aqua		100 μL	
Gray		250 μL	2.5 mL





Syringe termination

Termination refers to the interface between the syringe barrel and the needle.



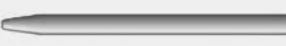

Many syringes are supplied and used with needles attached, such as fixed needle (FN) and removable needle (RN). Other terminations are available where the needle is not supplied - Luer Lock (LL), Luer Tip (LT), and threaded terminations.

Termination type	Details	Trajan's termination code
Fixed needle 	<ul style="list-style-type: none"> Recommended for autosampler use where the probability of needle bending is minimal. 	F
Removable needle 	<ul style="list-style-type: none"> Allows for the needle to be changed if damaged or for different applications. 	R
Luer Lock 	<ul style="list-style-type: none"> Fixed Luer Lock syringes have a Luer fitting that is permanently attached to the barrel. Removable needle versions have a Luer fitting that screws onto the barrel with the Luer Tip inserted. 	LL
Luer Tip 		LT
Thread 	<ul style="list-style-type: none"> Screw into a valve or other device, required for some LC autosamplers. Various threaded terminations are available. 	N/A

Needle selection

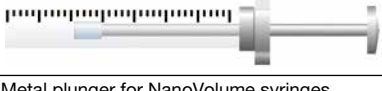
Needle tip style	Application	Features/applications	Trajan's tip code
Bevel 	Manual GC	<ul style="list-style-type: none"> A 20° tip which is typically used for manual injections. Designed for optimum septa penetration and prevention of septa coring. 	BV
Cone 	GC autosampler	<ul style="list-style-type: none"> Designed to withstand multi-injection requirements and improve septa lifetime when used with a GC autosampler. The needle passes through the septa during use and does not cause a slit. 	C
Dual gauge 	On-column injection - autosampler	<ul style="list-style-type: none"> Narrow gauge at the tip is suitable for large bore on-column injection. The wider gauge part of the needle gives increased strength to the needle for autosampler use. 	N/A
Square 	LC	<ul style="list-style-type: none"> Used for LC valve injection and have a 90° square tip with rounded and polished edges. This eliminates damage to the valve's rotor seal and stator face. 	LC
Dome 	With pre-drilled septa	<ul style="list-style-type: none"> The rounded and polished tip make this needle ideal for use with pre-drilled septa. 	D
Side hole 	Large volume injection (LVI)	<ul style="list-style-type: none"> Samples are filled and dispensed through the side hole eliminating septa plugging of the needle. Ideal for large volume gas injections and headspace. 	H

Plunger selection

Type	Features	Application
Metal plunger 	<ul style="list-style-type: none"> Stainless steel plunger individually fitted to its own syringe barrel. Plunger is not replaceable nor interchangeable. 	<ul style="list-style-type: none"> Industry-standard syringe for chromatography applications. For use when injection volume is greater than 1 µL.
PTFE and PE tipped plunger 	<ul style="list-style-type: none"> Plunger is replaceable. Easy to remove and clean to extend plunger lifetime. Capacities: 10 µL to 100 µL. 	<ul style="list-style-type: none"> Liquid and gas samples. Headspace applications. Ideal for samples with high levels of contaminants.
Metal plunger for NanoVolume syringes (plunger-in-needle) 	<ul style="list-style-type: none"> Plunger extends into the needle tip. Sample is contained only in the needle i.e. no glass contact. Capacities: 0.5 µL, 1 µL and 5 µL. 	<ul style="list-style-type: none"> Dispensing very small liquid volumes (less than 1 µL).
Superflex™ flexible plunger 	<ul style="list-style-type: none"> Made from titanium/nickel alloy. Virtually indestructible plunger. Capacities: 5 µL and 10 µL. 	<ul style="list-style-type: none"> Chromatography applications requiring greater plunger durability.
Plunger protection 	<ul style="list-style-type: none"> Extended protection from the top of the syringe back flange to help prevent plunger bending during injection and improve plunger stroke. Capacities: 5 µL and 10 µL. 	<ul style="list-style-type: none"> General use for both experienced and inexperienced users.
Guided plunger 	<ul style="list-style-type: none"> Extended barrel guides plunger during injection. Robust and rugged. Capacities: 5 µL and 10 µL. 	<ul style="list-style-type: none"> Industrial applications.

Syringe care and maintenance

Regular maintenance of a syringe is important for ensuring long life and robust performance.

Syringes should be routinely checked for damage to the barrel and needle. Look for fine cracks in the barrel. Needles should also be checked for burrs and rough surfaces which may cause tearing and excessive wear on the septa.

Syringe care, cleaning and use

Needle care: unblocking needles

1. Remove the plunger and fill the syringe with solvent using another syringe.
2. Insert plunger and gently push solvent through the needle. Never force the plunger as too much pressure may crack the syringe barrel.



Needle cleaning kit (part number 031782)

The syringe needle cleaning kits contain a range of stylet wires for needle cleaning, tweezers, and a surfactant material for barrel cleaning.

Syringe cleaning

1. Flush the syringe thoroughly with suitable solvents (such as methanol, methylene chloride, acetonitrile and acetone). Depending on the type of contaminant, this may have to be done up to 20 times.
2. Rinse with distilled water.
3. Flush with acetone.
4. Remove plunger and wipe with tissue.
5. Refit plunger and flush with acetone.
6. Allow syringe to dry.

Cleaning steps for NanoVolume syringes can be found in the manual supplied with the syringe.

Syringe temperature specifications

Heating will remove semi-volatile material from the syringe. Before heating or autoclaving, remove the plunger.

Syringe type	Maximum temperature
Fixed needle and fixed Luer	70°C
Removable needle and removable Luer	120°C
NanoVolume	70°C
Headspace	150°C

Rapid changes in temperature can lead to damage of the glass barrel. Ensure heating and cooling of a syringe is a gradual process.

Syringe use

- Always inspect the syringe before use. Check the barrel for cracks and the needle tip for burrs.
- To eliminate carryover between samples, flush the syringe with solvent 5-20 times, remembering to discard at least the first 2-3 washes.
- To eliminate air bubbles from the barrel, repeatedly draw and expel the sample while keeping the needle tip immersed in the solution. Bubbles can also be removed by turning the barrel upright while expelling some of the sample. If bubbles persist, slow the aspiration speed.
- To make an injection, overfill the syringe then press the plunger until the correct volume is reached. Draw the plunger back slightly, wipe the needle tip with a lint-free tissue, then make the injection. For improved precision, a repeating adaptor may be used to pre-set the volume.
- Before storage always flush the syringe with solvent and air dry.

Plunger care

Plunger type	Recommended care
Metal	<ul style="list-style-type: none"> • Never force the plunger. • Do not pump the plunger when the needle is blocked as the high pressure generated could crack the barrel. • Replacement plungers are not available. Plungers are individually fitted to the barrels to achieve a perfect seal. • Avoid unnecessary movement of plungers when the syringe is dry.
Metal for NanoVolume syringes	<ul style="list-style-type: none"> • Always loosen needle cover nut before removing or inserting plunger. • Wipe plunger with a lint-free tissue before replacing into the syringe.
PTFE and polyethylene (PE) tipped	<ul style="list-style-type: none"> • Avoid unnecessary movement of plungers when the syringe is dry. • Replacement PTFE and PE tipped plungers are available for many syringes.

Syringe troubleshooting

Problem	Cause	Solution
Blocked needles	Improper cleaning.	Refer to syringe cleaning tips (page 6).
	Inappropriate needle selection.	Refer to the needle selection guide (page 5).
Seized plungers	Poor dispensing technique.	Ensure correct injection technique is being followed.
	Build up of contaminants in samples.	Refer to syringe cleaning tips (page 6).
	Syringe installed in autosampler incorrectly.	Ensure the syringe is installed correctly.
Poor reproducibility	Incorrect syringe selection.	Refer to the selection guide (page 4), the dispensed volume should be greater than 10% of the entire syringe capacity.
	Operator technique.	Check that each sample is being injected in the same way.
	Incorrect instrument set up.	Check if any changes have been, or need to be made to your instrument or set up (septa, injection port liner etc.).
Air bubbles	Incorrect instrument set up.	Check if any changes have been, or need to be made to your instrument or set up (septa, injection port liner etc.).
Leakages	Incorrectly fitted needle.	Remove and refit the needle. Check the seal is in place and undamaged.
	No seal at plunger tip – plunger tip damaged or worn due to use or using syringe dry.	Replace plunger assembly if using a PTFE or PE tipped plunger.
Ghost peaks	Contaminated needle.	Between samples flush the syringe with solvent 5-20 times (discard at least the first 2-3 washes).

SGE GC autosampler syringes | Agilent

Product specifications and part numbers

Specifications			
Accuracy and reproducibility	±1% (dispensed volume) (±2% for 0.5 µL and 1 µL syringes)	Scale length	0.5 µL to 1 µL = 27.05 mm 5 µL to 10 µL = 54.1 mm 25 µL to 100 µL = 60 mm
Borosilicate glass barrel outer diameter (OD)	0.5 µL to 100 µL = 6.5 mm	International standards traceability	✓



Agilent 7693A, 7683, 7673, 7650A and 6850ALS

Syringe part number	Volume	Needle length (mm)	Needle gauge	Needle OD (mm)	Needle ID (mm)	Needle tip	Pack size	Replacement needle part number	Replacement plunger part number
Fixed needle syringes									
001800	5 µL	42	26	0.47	0.11	Cone	1	-	-
001804	5 µL	42	26	0.47	0.11	Cone	6	-	-
001810	5 µL	42	23	0.63	0.11	Cone	1	-	-
001814	5 µL	42	23	0.63	0.11	Cone	6	-	-
001821	5 µL	42	23/26	0.63/0.47	0.11	Cone	1	-	-
001822	5 µL	42	23/26	0.63/0.47	0.11	Cone	6	-	-
002800	10 µL	42	26	0.47	0.11	Cone	1	-	-
002804	10 µL	42	26	0.47	0.11	Cone	6	-	-
002810	10 µL	42	23	0.63	0.11	Cone	1	-	-
002811	10 µL	42	23	0.63	0.11	Side hole	1	-	-
002813	10 µL	42	23	0.63	0.11	Cone	25	-	-
002814	10 µL	42	23	0.63	0.11	Cone	6	-	-
002821	10 µL	42	23/26	0.63/0.47	0.11	Cone	1	-	-
002822	10 µL	42	23/26	0.63/0.47	0.11	Cone	6	-	-
002824	10 µL	42	23/26	0.63/0.47	0.11	Cone	25	-	-
Fixed needle, gas tight syringes									
002812	10 µL	42	23	0.63	0.11	Cone	1	-	031808
002816	10 µL	42	23	0.63	0.11	Cone	25	-	031808
002826	10 µL	42	23/26	0.63/0.47	0.11	Cone	1	-	031808
002827	10 µL	42	23/26	0.63/0.47	0.11	Cone	6	-	031808
003668	25 µL	42	23/26	0.63/0.47	0.24	Cone	1	-	-
004668	50 µL	42	23/26	0.63/0.47	0.24	Cone	1	-	-
005668	100 µL	42	23/26	0.63/0.47	0.24	Cone	1	-	031823
Fixed needle syringes with Superflex plunger									
002831	10 µL	42	26	0.47	0.11	Cone	6	-	-
002838	10 µL	42	23	0.63	0.11	Cone	6	-	-
Removable needle syringes									
000400	0.5 µL	42	26	0.47	0.15	Cone	1	033708*	-
000410	0.5 µL	42	23	0.63	0.15	Cone	1	033715*	-
000415	0.5 µL	42	23/26	0.63/0.47	0.1	Cone	1	033730*	-
000610	1 µL	42	23	0.63	0.22	Cone	1	034715*	-
002805	10 µL	42	26	0.47	0.11	Cone	1	037715	-
002815	10 µL	42	23	0.63	0.11	Cone	1	037717	-
004665	50 µL	42	23	0.63	0.24	Cone	1	038717	-
Removable needle, gas tight syringes									
002820	10 µL	42	23	0.63	0.11	Cone	10	037717	031809
002829	10 µL	42	23/26	0.63/0.47	0.11	Cone	1	037730	031809

*Denotes needle and plunger kit.

SGE GC autosampler syringes | CTC Analytics

Product specifications and part numbers

Specifications			
Accuracy and reproducibility	±1% (dispensed volume) (±2% for 0.5 µL and 1 µL syringes)	Scale length	0.5 µL to 1 µL = 27.05 mm 5 µL to 10 µL = 54.1 mm 25 µL to 5 mL = 60 mm
Borosilicate glass barrel outer diameter (OD)	0.5 µL to 100 µL = 6.5 mm 250 µL to 500 µL = 8 mm 1 mL = 7.6 mm 2.5 mL = 9.7 mm 5 mL = 14 mm	International standards traceability	✓

Syringes listed in the following part number tables (pages 9-10) are suitable for:

- CTC Analytics PAL RTC (PAL3)
- Shimadzu AOC-6000
- Thermo Scientific TriPlus RSH
- Agilent PAL3

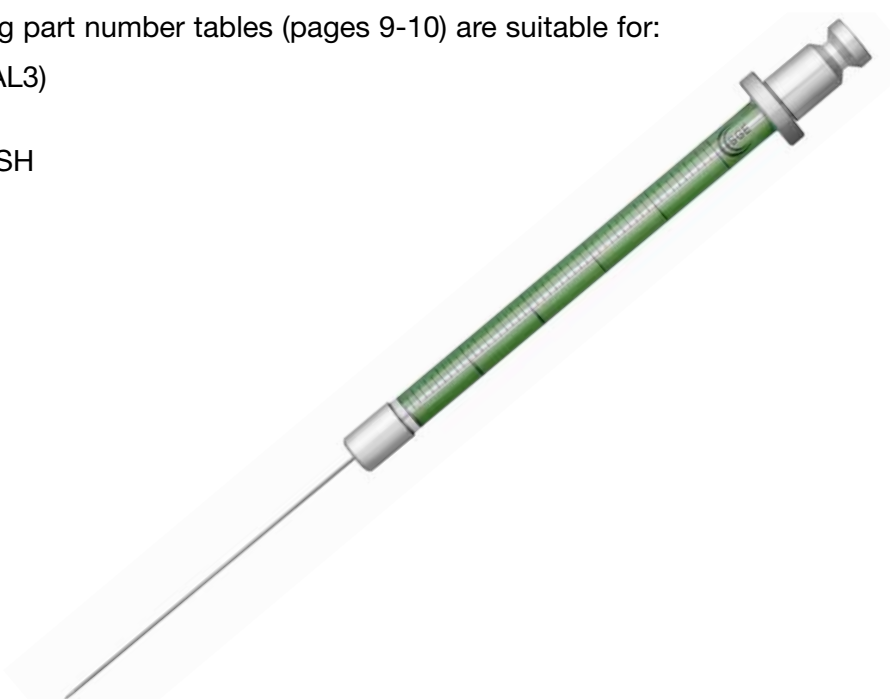

CTC Analytics PAL3 RTC, Shimadzu AOC-6000, Thermo Scientific TriPlus RSH and Agilent PAL3

Syringe part number	Volume	Needle length (mm)	Needle gauge	Needle OD (mm)	Needle ID (mm)	Needle tip	Pack size	Replacement needle part number	Replacement plunger part number
Fixed needle syringes									
001861	5 µL	57	23	0.63	0.11	Cone	1	-	-
001863	5 µL	85	23	0.63	0.11	Cone	1	-	-
001865	5 µL	57	26	0.47	0.11	Cone	1	-	-
002861	10 µL	57	23	0.63	0.11	Cone	1	-	-
002863	10 µL	85	23	0.63	0.11	Cone	1	-	-
002865	10 µL	57	26	0.47	0.11	Cone	1	-	-
002867	10 µL	85	26	0.47	0.11	Cone	1	-	-
002869	10 µL	85	26	0.47	0.11	Bevel	1	-	-
Fixed needle, gas tight syringes									
002862	10 µL	57	23	0.63	0.11	Cone	1	-	032810
002864	10 µL	85	23	0.63	0.11	Cone	1	-	032810
002866	10 µL	57	26	0.47	0.11	Cone	1	-	032810
002868	10 µL	85	26	0.47	0.11	Cone	1	-	032810

CTC Analytics PAL3 RTC, Shimadzu AOC-6000, Thermo Scientific TriPlus RSH and Agilent PAL3 continued

Syringe part number	Volume	Needle length (mm)	Needle gauge	Needle OD (mm)	Needle ID (mm)	Needle tip	Pack size	Replacement needle part number	Replacement plunger part number
Fixed needle, gas tight syringes continued									
003862	25 µL	57	23	0.63	0.11	Cone	1	-	
003864	25 µL	85	23	0.63	0.11	Cone	1	-	032815
003866	25 µL	57	26	0.47	0.11	Cone	1	-	032815
003868	25 µL	85	26	0.47	0.11	Cone	1	-	032815
004862	50 µL	57	23	0.63	0.11	Cone	1	-	032821
004864	50 µL	85	23	0.63	0.11	Cone	1	-	032821
004866	50 µL	57	26	0.47	0.11	Cone	1	-	032821
004868	50 µL	85	26	0.47	0.11	Cone	1	-	032821
005862	100 µL	57	23	0.63	0.11	Cone	1	-	032825
005864	100 µL	85	23	0.63	0.11	Cone	1	-	032825
005866	100 µL	57	26	0.47	0.11	Cone	1	-	032825
005868	100 µL	85	26	0.47	0.11	Cone	1	-	032825
005890	100 µL	57	23	0.63	0.32	Side hole	1	-	032825
005891	100 µL	85	23	0.63	0.32	Side hole	1	-	032825
006862	250 µL	57	23	0.63	0.32	Cone	1	-	032831
006864	250 µL	85	23	0.63	0.32	Cone	1	-	032831
006866	250 µL	57	26	0.47	0.2	Cone	1	-	032831
006868	250 µL	85	26	0.47	0.2	Cone	1	-	032831
006890	250 µL	57	23	0.63	0.32	Side hole	1	-	032831
006891	250 µL	85	23	0.63	0.32	Side hole	1	-	032831
007862	500 µL	57	23	0.63	0.32	Cone	1	-	032835
007864	500 µL	85	23	0.63	0.32	Cone	1	-	032835
007866	500 µL	57	26	0.47	0.2	Cone	1	-	032835
007868	500 µL	85	26	0.47	0.2	Cone	1	-	032835
007890	500 µL	57	23	0.63	0.32	Side hole	1	-	032835
007891	500 µL	85	23	0.63	0.32	Side hole	1	-	032835
008155	1 mL	65	23	0.63	0.15	Side hole	1	-	032841
008655	2.5 mL	65	23	0.63	0.15	Side hole	1	-	032846
008855	5 mL	65	23	0.63	0.15	Side hole	1	-	032851
Removable needle syringes									
000480	0.5 µL	57	23	0.63	0.15	Cone	1	033780*	-
000680	1 µL	57	23	0.63	0.22	Cone	1	034780*	-
001871	5 µL	57	23	0.63	0.11	Cone	1	036871	-
001875	5 µL	57	26	0.47	0.11	Cone	1	036875	-
001877	5 µL	85	26	0.47	0.11	Cone	1	036877	-
002871	10 µL	57	23	0.63	0.11	Cone	1	037871	-
002875	10 µL	57	26	0.47	0.11	Cone	1	037875	-
Removable needle, gas tight syringes									
002872	10 µL	57	23	0.63	0.11	Cone	1	037871	032810
002874	10 µL	85	23	0.63	0.11	Cone	1	037873	032810
002876	10 µL	57	26	0.47	0.11	Cone	1	037875	032810
002878	10 µL	85	26	0.47	0.11	Cone	1	037877	032810

*Denotes needle and plunger kit.

SGE GC autosampler syringes | PerkinElmer

Product specifications and part numbers

Specifications			
Accuracy and reproducibility	±1% (dispensed volume) (±2% for 0.5 µL syringes)	Scale length	0.5 µL to 5 µL = 27.05 mm 50 µL = 54.1 mm
Borosilicate glass barrel outer diameter (OD)	0.5 µL to 50 µL = 6.5 mm	International standards traceability	✓



PerkinElmer Clarus 690, 590, 600, 500 and AutoSystem

Syringe part number	Volume	Needle length (mm)	Needle gauge	Needle OD (mm)	Needle ID (mm)	Needle tip	Pack size	Replacement needle part number	Replacement plunger part number
Fixed needle syringes									
001953	5 µL	70	26	0.47	0.15	Cone	1	-	-
001954	5 µL	70	23	0.63	0.15	Cone	1	-	-
004670	50 µL	70	23	0.63	0.24	Cone	1	-	-
Fixed needle, gas tight syringes									
001955	5 µL	70	26	0.47	0.15	Cone	1	-	031807
001957	5 µL	70	23	0.63	0.15	Cone	1	-	031807
Removable needle syringes									
000475	0.5 µL	70	26	0.47	0.1	Cone	1	033750*	-
000478	0.5 µL	70	23	0.63	0.1	Cone	1	033765*	-

*Denotes needle and plunger kit.

SGE GC autosampler syringes | Scion Instruments

Product specifications and part numbers

Specifications			
Accuracy and reproducibility	±1% (dispensed volume)	Scale length	5 µL to 25 µL = 54.1 mm
Borosilicate glass barrel outer diameter (OD)	5 µL to 25 µL = 6.5 mm	International standards traceability	✓



Scion Instruments 8410 PRO and 8400 PRO

Syringe part number	Volume	Needle length (mm)	Needle gauge	Needle OD (mm)	Needle ID (mm)	Needle tip	Pack size	Replacement plunger part number
Fixed needle syringes								
0019811	5 µL	50	23	0.63	0.11	Cone	1	-
0019821	5 µL	50	26	0.47	0.11	Cone	1	-
0029801	10 µL	50	26	0.47	0.11	Cone	1	-
0029861	10 µL	50	26	0.47	0.11	Cone	6	-
Fixed needle, gas tight syringes								
0029761	10 µL	50	26	0.47	0.11	Cone	6	03181201
0029771	10 µL	50	26	0.47	0.11	Cone	1	03181201
0029871	10 µL	50	23	0.63	0.11	Cone	1	03181201
0039871	25 µL	50	23	0.63	0.24	Cone	1	0318171

SGE GC autosampler syringes | Shimadzu

Product specifications and part numbers

Specifications			
Accuracy and reproducibility	±1% (dispensed volume) (±2% for 0.5 µL syringes)	Scale length	0.5 µL = 27.05 mm 5 µL to 10 µL = 54.1 mm
Borosilicate glass barrel outer diameter (OD)	0.5 µL to 10 µL = 6.5 mm	International standards traceability	✓



Shimadzu AOC-20i, AOC-20, AOC-17 and AOC-14

Syringe part number	Volume	Needle length (mm)	Needle gauge	Needle OD (mm)	Needle ID (mm)	Needle tip	Pack size	Replacement needle part number	Replacement plunger part number
Fixed needle syringes									
001988	5 µL	42	23	0.63	0.11	Cone	1	-	-
Removable needle syringes									
000440	0.5 µL	42	26	0.47	0.1	Cone	1	033738*	-
000445	0.5 µL	42	23	0.63	0.1	Cone	1	033745*	-
002897	10 µL	42	26	0.47	0.11	Cone	1	037745	-
002898	10 µL	42	23	0.63	0.11	Cone	1	037747	-
Removable needle, gas tight syringes									
002902	10 µL	42	23	0.63	0.11	Cone	1	037747	031798

*Denotes needle and plunger kit.

SGE GC autosampler syringes | Thermo Scientific

Product specifications and part numbers

Specifications			
Accuracy and reproducibility	±1% (dispensed volume) (±2% for 0.5 µL and 2 µL syringes)	Scale length	0.5 µL to 1 µL = 27.05 mm 5 µL to 10 µL = 54.1 mm 25 µL to 5 mL = 60 mm
Borosilicate glass barrel outer diameter (OD)	0.5 µL to 100 µL = 6.5 mm 250 µL to 500 µL = 8 mm 1 mL = 7.6 mm 2.5 mL = 9.7 mm 5 mL = 14 mm	International standards traceability	✓

For syringes for TriPlus RSH, see pages 9-10 and 15.



Thermo Scientific AI/AS 1610, AI/AS 1310 and TriPlus

Syringe part number	Volume	Needle length (mm)	Needle gauge	Needle OD (mm)	Needle ID (mm)	Needle tip	Pack size	Replacement needle part number	Replacement plunger part number
Fixed needle syringes									
001981	5 µL	50	23	0.63	0.11	Cone	1	-	-
001982	5 µL	50	26	0.47	0.11	Cone	1	-	-
002967	10 µL	50	25	0.5	0.11	Cone	1	-	-
002971	10 µL	50	23	0.63	0.11	Cone	6	-	-
002980	10 µL	50	26	0.47	0.11	Cone	1	-	-
002981	10 µL	50	23	0.63	0.11	Cone	1	-	-
002986	10 µL	50	26	0.47	0.11	Cone	6	-	-
Fixed needle, gas tight syringes									
002972	10 µL	50	23	0.63	0.11	Cone	6	-	031803 (PK1) 0318120 (PK2)
002976	10 µL	50	26	0.47	0.11	Cone	6	-	031803 (PK1) 0318120 (PK2)
002977	10 µL	50	26	0.47	0.11	Cone	1	-	031803 (PK1) 0318120 (PK2)
002987	10 µL	50	23	0.63	0.11	Cone	1	-	031803 (PK1) 0318120 (PK2)
003987	25 µL	50	23	0.63	0.24	Cone	1	-	031817
005335	100 µL	50	23	0.63	0.24	Cone	1	-	0318261
008131	1 mL	56	23	0.63	0.15	Side hole	1	-	031841
008136	1 mL	56	26	0.47	0.15	Side hole	1	-	031841
008631	2.5 mL	56	23	0.63	0.15	Side hole	1	-	031851
008636	2.5 mL	56	26	0.47	0.15	Side hole	1	-	031851
008831	5 mL	56	23	0.63	0.15	Side hole	1	-	031861
Removable needle syringes									
000490	0.5 µL	50	26	0.47	0.15	Cone	1	033770*	-
000492	0.5 µL	50	23	0.63	0.15	Cone	1	033772*	-
000790	2 µL	50	23	0.63	0.22	Cone	1	034905*	-
001984	5 µL	50	23	0.63	0.11	Cone	1	036011	-
002982	10 µL	50	26	0.47	0.11	Cone	1	037010	-
002984	10 µL	50	23	0.63	0.11	Cone	1	037787	-
Removable needle, gas tight syringes									
002985	10 µL	50	26	0.47	0.11	Cone	1	037010	0318121
003988	25 µL	50	26	0.47	0.24	Side hole	1	038749	031816
005333	100 µL	50	26	0.47	0.2	Cone	1	038732	031826

*Denotes needle and plunger kit.

Thermo Scientific AS3000 and AS2000

Syringe part number	Volume	Needle length (mm)	Needle gauge	Needle OD (mm)	Needle ID (mm)	Needle tip	Pack size	Replacement needle part number	Replacement plunger part number
Fixed needle syringes									
0019811	5 µL	50	23	0.63	0.11	Cone	1	-	-
0019821	5 µL	50	26	0.47	0.11	Cone	1	-	-
0029671	10 µL	50	25	0.5	0.11	Cone	1	-	-
0029741	10 µL	80	22	0.72	0.17	Cone	1	-	-
0029781	10 µL	70	26	0.47	0.11	Cone	1	-	-
0029801	10 µL	50	26	0.47	0.11	Cone	1	-	-
0029861	10 µL	50	26	0.47	0.11	Cone	6	-	-
0029891	10 µL	80	23	0.63	0.11	Cone	1	-	-
0029921	10 µL	80	26	0.47	0.15	Cone	1	-	-
Fixed needle, gas tight syringes									
0029761	10 µL	50	26	0.47	0.11	Cone	6	-	03181201
0029771	10 µL	50	26	0.47	0.11	Cone	1	-	03181201
0029871	10 µL	50	23	0.63	0.11	Cone	1	-	03181201
0039871	25 µL	50	23	0.63	0.24	Cone	1	-	0318171
Removable needle syringes									
0029841	10 µL	50	23	0.63	0.11	Cone	1	037787	-
0029931	10 µL	80	26	0.47	0.15	Cone	1	031535	-



L-MARK LC autosampler syringes | CTC Analytics

Product specifications and part numbers

Specifications			
Accuracy and reproducibility	±1% (dispensed volume)	Scale length	10 µL = 54.1 mm 25 µL to 10 mL = 60 mm
Borosilicate glass barrel outer diameter (OD)	10 µL to 100 µL = 6.5 mm 250 µL to 500 µL = 8 mm 1 mL = 7.6 mm 5 mL = 14 mm 10 mL = 18 mm	International standards traceability	✓

CTC Analytics PAL DLW (Dynamic Load and Wash)

Syringe part number	Volume	Pack size	Replacement needle part number (PK3)	Replacement plunger part number (PK6)
LMK.2620736	100 µL	1	LMK.21080733	LMK.2636735
LMK.2620740	100 µL	1	LMK.21080733	-
LMK.2620735-BL	100 µL	1	LMK.21080733	LMK.2636735-BL
LMK.2620835-BL	250 µL	1	LMK.21080733	LMK.2636835-BL
LMK.2620935-BL	500 µL	1	LMK.21080733	LMK.2636935-BL
LMK.2620080-BL	1 mL	1	LMK.21080733	LMK.2636086-BL



CTC Analytics PAL3 RTC and Thermo Scientific TriPlus RSH

Syringe part number	Volume	Needle length (mm)	Needle gauge	Needle OD (mm)	Needle ID (mm)	Needle tip	Pack size
Fixed needle, gas tight syringes (PTFE plunger)							
LMK.2616422C*	10 µL	57	22s	0.72	0.17	LC	1
LMK.2616422	10 µL	57	22s	0.72	0.17	LC	1
LMK.3030021	10 µL	85	22s	0.72	0.17	LC	1
LMK.3030022	25 µL	57	22s	0.72	0.17	LC	1
LMK.2616502C*	25 µL	57	22s	0.72	0.17	LC	1
LMK.2616704C*	100 µL	57	22	0.72	0.37	LC	1
LMK.3030908	100 µL	85	22s	0.72	0.17	LC	1
LMK.2616822	250 µL	57	22s	0.72	0.17	LC	1
LMK.3030029	250 µL	57	22	0.72	0.37	LC	1
LMK.2616922	500 µL	57	22s	0.72	0.17	LC	1
LMK.3030031	1 mL	57	22s	0.72	0.17	LC	1
LMK.3030095	5 mL	57	22	0.72	0.37	LC	1
LMK.3030485	10 mL	57	19	1.07	0.65	LC	1

*Denotes L-MARK Gold syringe.



CTC Analytics PAL-xt

Syringe part number	Volume	Needle length (mm)	Needle gauge	Needle OD (mm)	Needle ID (mm)	Needle tip	Pack size
L-MARK Gold syringes							
Fixed needle, gas tight syringes (PTFE plunger)							
LMK.2606416C	10 µL	51	22s	0.72	0.17	LC	1
LMK.2606416C-6P	10 µL	51	22s	0.72	0.17	LC	6
LMK.2620517C	25 µL	51	22s	0.72	0.17	LC	1
LMK.2620517C-6P	25 µL	51	22s	0.72	0.17	LC	6
LMK.2620521C	25 µL	51	22	0.72	0.37	LC	1
LMK.2620617C	50 µL	51	22s	0.72	0.17	LC	1
LMK.2620615C	50 µL	51	22	0.72	0.37	LC	1
LMK.2620719C	100 µL	51	22s	0.72	0.17	LC	1
LMK.2620719C-2P	100 µL	51	22s	0.72	0.17	LC	2
LMK.2620719C-6P	100 µL	51	22s	0.72	0.17	LC	6
LMK.2620721C	100 µL	51	22	0.72	0.37	LC	1
LMK.2620721C-6P	100 µL	51	22	0.72	0.37	LC	6
LMK.2620821C	250 µL	51	22	0.72	0.37	LC	1
LMK.2620821C-6P	250 µL	51	22	0.72	0.37	LC	6
Fixed needle, gas tight syringes (black PTFE plunger)							
LMK.2606416C-BL	10 µL	51	22s	0.72	0.17	LC	1
LMK.2620517C-BL	25 µL	51	22s	0.72	0.17	LC	1
LMK.2620617C-BL	50 µL	51	22s	0.72	0.17	LC	1
LMK.2620615C-BL	50 µL	51	22	0.72	0.37	LC	1
LMK.2620719C-BL	100 µL	51	22s	0.72	0.17	LC	1
LMK.2620719CBL6	100 µL	51	22s	0.72	0.17	LC	6
LMK.2620721C-BL	100 µL	51	22	0.72	0.37	LC	1
LMK.2620821C-BL	250 µL	51	22	0.72	0.37	LC	1
Fixed needle, gas tight syringes (PE plunger)							
LMK.2620518C	25 µL	51	22s	0.72	0.17	LC	1
LMK.2620616C	50 µL	51	22s	0.72	0.17	LC	1
LMK.2620616C-6P	50 µL	51	22s	0.72	0.17	LC	6
LMK.2620614C	50 µL	51	22	0.72	0.37	LC	1
LMK.2620718C	100 µL	51	22s	0.72	0.17	LC	1
LMK.2620720C	100 µL	51	22	0.72	0.37	LC	1
LMK.2620820C	250 µL	51	22	0.72	0.37	LC	1



CTC Analytics PAL-xt continued

Syringe part number	Volume	Needle length (mm)	Needle gauge	Needle OD (mm)	Needle ID (mm)	Needle tip	Pack size	Replacement plunger part number
L-MARK syringes								
Fixed needle, gas tight syringes (PTFE plunger)								
LMK.2606416	10 µL	51	22s	0.72	0.17	LC	1	-
LMK.2606416-2P	10 µL	51	22s	0.72	0.17	LC	2	-
LMK.2606416-6P	10 µL	51	22s	0.72	0.17	LC	6	-
LMK.2620517	25 µL	51	22s	0.72	0.17	LC	1	LMK.2636505
LMK.2620517-2P	25 µL	51	22s	0.72	0.17	LC	2	LMK.2636505-2P
LMK.2620517-6P	25 µL	51	22s	0.72	0.17	LC	6	LMK.2636505-6P
LMK.2620617	50 µL	51	22s	0.72	0.17	LC	1	LMK.2636605
LMK.2620617-2P	50 µL	51	22s	0.72	0.17	LC	2	LMK.2636605-2P
LMK.2620617-6P	50 µL	51	22s	0.72	0.17	LC	6	LMK.2636605-6P
LMK.2620615	50 µL	51	22	0.72	0.37	LC	1	LMK.2636605
LMK.2620615-2P	50 µL	51	22	0.72	0.37	LC	2	LMK.2636605-2P
LMK.2620615-6P	50 µL	51	22	0.72	0.37	LC	6	LMK.2636605-6P
LMK.2620719	100 µL	51	22s	0.72	0.17	LC	1	LMK.2636707
LMK.2620719-2P	100 µL	51	22s	0.72	0.17	LC	2	LMK.2636707-2P
LMK.2620719-6P	100 µL	51	22s	0.72	0.17	LC	6	LMK.2636707-6P
LMK.2620721	100 µL	51	22	0.72	0.37	LC	1	LMK.2636707
LMK.2620721-2P	100 µL	51	22	0.72	0.37	LC	2	LMK.2636707-2P
LMK.2620721-6P	100 µL	51	22	0.72	0.37	LC	6	LMK.2636707-6P
LMK.2620821	250 µL	51	22	0.72	0.37	LC	1	-
LMK.2620821-2P	250 µL	51	22	0.72	0.37	LC	2	-
LMK.2620821-6P	250 µL	51	22	0.72	0.37	LC	6	-
Fixed needle, gas tight syringes (black PTFE plunger)								
LMK.2606416BL	10 µL	51	22s	0.72	0.17	LC	1	-
LMK.2606416B-6P	10 µL	51	22s	0.72	0.17	LC	6	-
LMK.2620517BL	25 µL	51	22s	0.72	0.17	LC	1	-
LMK.2620617BL	50 µL	51	22s	0.72	0.17	LC	1	-
LMK.2620617BL6P	50 µL	51	22s	0.72	0.17	LC	6	-
LMK.2620719-BL	100 µL	51	22s	0.72	0.17	LC	1	-
LMK.2620719B-6P	100 µL	51	22s	0.72	0.17	LC	6	-
Fixed needle, gas tight syringes (PE plunger)								
LMK.2620518	25 µL	51	22s	0.72	0.17	LC	1	-
LMK.2620518-6P	25 µL	51	22s	0.72	0.17	LC	6	-
LMK.2620616	50 µL	51	22s	0.72	0.17	LC	1	LMK.2636606
LMK.2620616-2P	50 µL	51	22s	0.72	0.17	LC	2	LMK.2636606-2P
LMK.2620616-6P	50 µL	51	22s	0.72	0.17	LC	6	LMK.2636606-6P
LMK.2620614	50 µL	51	22	0.72	0.37	LC	1	LMK.2636606
LMK.2620614-2P	50 µL	51	22	0.72	0.37	LC	2	LMK.2636606-2P
LMK.2620614-6P	50 µL	51	22	0.72	0.37	LC	6	LMK.2636606-6P
LMK.2620718	100 µL	51	22s	0.72	0.17	LC	1	LMK.2636708
LMK.2620718-2P	100 µL	51	22s	0.72	0.17	LC	2	LMK.2636708-2P
LMK.2620718-6P	100 µL	51	22s	0.72	0.17	LC	6	LMK.2636708-6P
LMK.2620720	100 µL	51	22	0.72	0.37	LC	1	LMK.2636708
LMK.2620720-2P	100 µL	51	22	0.72	0.37	LC	2	LMK.2636708-2P
LMK.2620720-6P	100 µL	51	22	0.72	0.37	LC	6	LMK.2636708-6P
LMK.2620820	250 µL	51	22	0.72	0.37	LC	1	LMK.2636808
LMK.2620820-2P	250 µL	51	22	0.72	0.37	LC	2	LMK.2636808-2P
LMK.2620820-6P	250 µL	51	22	0.72	0.37	LC	6	LMK.2636808-6P



SGE LC autosampler syringes | PerkinElmer

Product specifications and part numbers

Specifications			
Accuracy and reproducibility	±1% (dispensed volume)	Scale length	50 µL to 2.5 mL = 60 mm
Borosilicate glass barrel outer diameter (OD)	50 µL to 500 µL = 8 mm 1 mL = 9 mm 2.5 mL = 11 mm	International standards traceability	✓



PerkinElmer Series 200

Syringe part number	Volume	Termination	Pack size
004995	50 µL	¼-28 UNF	1
005990	100 µL	¼-28 UNF	1
006995	250 µL	¼-28 UNF	1
007995	500 µL	¼-28 UNF	1
008185	1 mL	¼-28 UNF	1
008687	2.5 mL	¼-28 UNF	1

SGE LC autosampler syringes | Waters

Product specifications and part numbers

Specifications			
Accuracy and reproducibility	±1% (dispensed volume)	Scale length	25 µL to 250 µL = 60 mm
Borosilicate glass barrel outer diameter (OD)	25 µL to 250 µL = 8 mm	International standards traceability	✓



Waters WISP

Syringe part number	Volume	Termination	Pack size	Replacement plunger part number
003990	25 µL	¼-28 UNF	1	031819
006690	250 µL	¼-28 UNF	1	031834

SGE LC manual syringes | Rheodyne and Valco

Product specifications and part numbers

Specifications			
Accuracy and reproducibility	±1% (dispensed volume)	Scale length	5 µL to 10 µL = 54.1 mm 25 µL to 2.5 mL = 60 mm
Borosilicate glass barrel outer diameter (OD)	5 µL to 10 µL = 6.5 mm 25 µL to 500 µL = 8 mm 1 mL = 9 mm 2.5 mL = 11 mm	International standards traceability	✓



Rheodyne and Valco valves

Syringe part number	Volume	Needle length (mm)	Needle gauge	Needle OD (mm)	Needle ID (mm)	Needle tip	Pack size	Replacement needle part number	Replacement plunger part number
Fixed needle syringes									
001301	5 µL	51	22s	0.72	0.17	LC	1	-	-
002301	10 µL	51	22s	0.72	0.17	LC	1	-	-
002315	10 µL	51	22s	0.72	0.17	LC	6	-	-
003300	25 µL	51	22	0.72	0.37	LC	1	-	-
004300	50 µL	51	22	0.72	0.37	LC	1	-	-
005300	100 µL	51	22	0.72	0.37	LC	1	-	-
006300	250 µL	51	22	0.72	0.37	LC	1	-	-
007300	500 µL	51	22	0.72	0.37	LC	1	-	-
Fixed needle, gas tight syringes									
002335	10 µL	51	22s	0.72	0.17	LC	1	-	031810
Fixed needle syringes with Superflex plunger									
002300	10 µL	51	22s	0.72	0.17	LC	1	-	-
002330	10 µL	51	22s	0.72	0.17	LC	6	-	-
Removable needle syringes									
006310	250 µL	51	22	0.72	0.37	LC	1	038250	-
007310	500 µL	51	22	0.72	0.37	LC	1	038250	-
Removable needle, gas tight syringes									
002313	10 µL	51	22s	0.72	0.17	LC	1	037250	031811
003312	25 µL	51	22	0.72	0.37	LC	1	038250	031815
004312	50 µL	51	22	0.72	0.37	LC	1	038250	031820
005312	100 µL	51	22	0.72	0.37	LC	1	038250	031825
006312	250 µL	51	22	0.72	0.37	LC	1	038250	031830
007312	500 µL	51	22	0.72	0.37	LC	1	038250	031835
008105	1 mL	51	22	0.72	0.37	LC	1	039250	031842
008505	2.5 mL	51	22	0.72	0.37	LC	1	039250	-

SGE syringes | NanoVolume

Product specifications and part numbers

Specifications			
Accuracy and reproducibility	±2% (dispensed volume)	Scale length	0.5 µL and 1 µL = 54.1 mm 5 µL = 48.7 mm
Borosilicate glass barrel outer diameter (OD)	0.5 µL to 5 µL = 8 mm (except part numbers 000300, 000301, 000303, 000350, 000353 = 6.5 mm)	International standards traceability	✓

With the ability to inject down to 50 nL with high precision and accuracy, SGE NanoVolume syringes are perfect for NanoVolume capillary chromatography injection as well as making accurate standards that require small volumes.

The sample is only drawn into the needle, not the syringe barrel. When the plunger is depressed, the sample is completely dispensed by the NanoVolume plunger that extends to the tip of the needle.

Displacing the full sample during injection results in virtually zero dead volume and carry over between injections.

The plungers and needles are matched sets and must be replaced as a set.

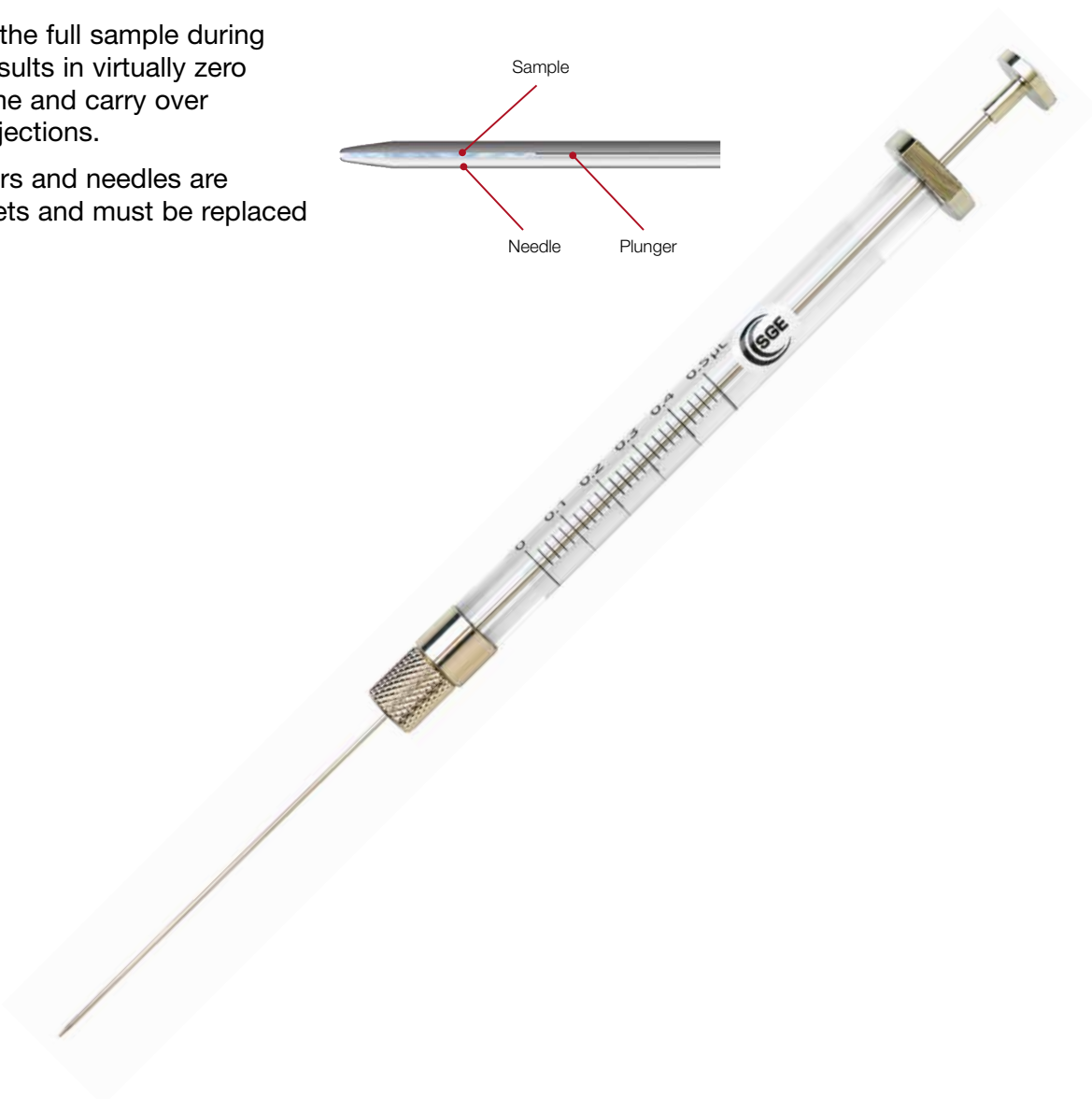
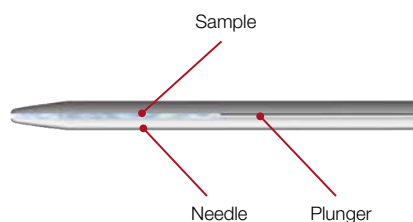

NanoVolume syringes

Syringe part number	Volume	Needle length (mm)	Needle gauge	Needle OD (mm)	Needle ID (mm)	Needle tip	Pack size	Replacement needle and plunger part number
NanoVolume syringes								
000300	0.5 µL	50	23	0.63	0.15	Cone	1	033010
000301	0.5 µL	50	23	0.63	0.15	Bevel	1	033011
000303	0.5 µL	50	26	0.47	0.15	Cone	1	033012
000310	0.5 µL	70	23	0.63	0.1	Cone	1	033057
000311	0.5 µL	70	23	0.63	0.1	Bevel	1	033060
000376	0.5 µL	70	26	0.47	0.1	Cone	1	033630
000380	0.5 µL	75	26	0.47	0.1	On-column	1	033620
000500	1 µL	50	23	0.63	0.15	Cone	1	034055
000501	1 µL	50	23	0.63	0.15	Bevel	1	034056
000505	1 µL	70	23	0.63	0.15	Cone	1	034057
000506	1 µL	70	23	0.63	0.15	Bevel	1	034060
000510	1 µL	115	23	0.63	0.15	Cone	1	034059
000570	1 µL	70	26	0.47	0.15	Cone	1	034610
000800	5 µL	50	23	0.63	0.37	Cone	1	035055
000801	5 µL	50	23	0.63	0.37	Bevel	1	035056
000802	5 µL	70	23	0.63	0.37	Cone	1	035057
000803	5 µL	70	23	0.63	0.37	Bevel	1	035058
000804	5 µL	115	23	0.63	0.37	Cone	1	-
NanoVolume syringes with repeating adaptor								
000350	0.5 µL	50	23	0.63	0.15	Cone	1	033010
000353	0.5 µL	50	26	0.47	0.15	Cone	1	033012
000355	0.5 µL	70	23	0.63	0.1	Cone	1	033057
000550	1 µL	50	23	0.63	0.15	Cone	1	034055
000553	1 µL	70	23	0.63	0.15	Cone	1	034057
000850	5 µL	50	23	0.63	0.37	Cone	1	035055
000852	5 µL	70	23	0.63	0.37	Cone	1	035057

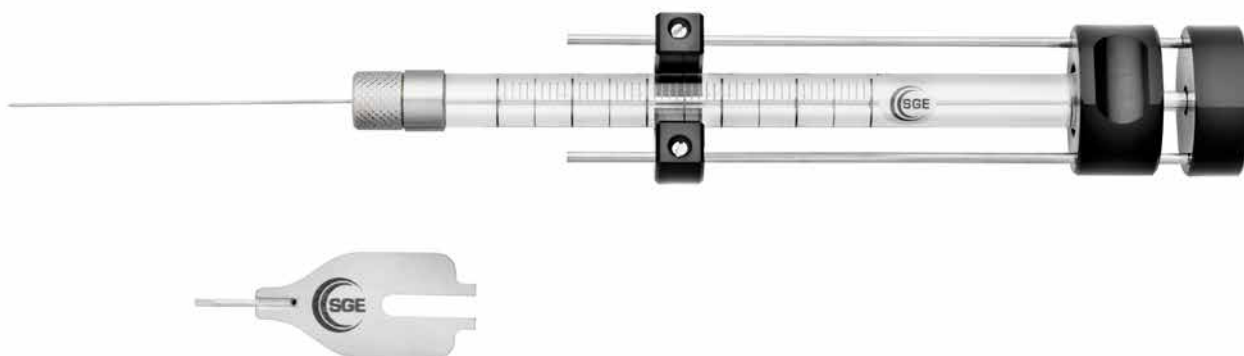

SGE syringes | Manual

Product specifications and part numbers

Specifications			
Accuracy and reproducibility	Operator dependent	Scale length	5 µL to 10 µL = 54.1 mm 25 µL to 10 mL = 60 mm
Borosilicate glass barrel outer diameter (OD)	5 µL to 10 µL = 6.5 mm 25 µL to 500 µL = 8 mm 1 mL = 9 mm 2.5 mL = 11 mm 5 mL = 14 mm 10 mL = 18 mm	International standards traceability	✓



General purpose manual syringes

Syringe part number	Volume	Needle length (mm)	Needle gauge	Needle OD (mm)	Needle ID (mm)	Needle tip	Pack size	Replacement needle part number	Replacement plunger part number
Fixed needle, metal syringes									
001000	5 µL	50	26	0.47	0.11	Bevel	1	-	-
002000	10 µL	50	26	0.47	0.11	Bevel	1	-	-
002003	10 µL	70	26	0.47	0.11	Bevel	1	-	-
002005	10 µL	50	26	0.47	0.11	Cone	1	-	-
002030	10 µL	50	26	0.47	0.11	Bevel	6	-	-
002033	10 µL	50	26	0.47	0.11	Bevel	10	-	-
002035	10 µL	50	26	0.47	0.11	Bevel	25	-	-
003000	25 µL	50	25	0.5	0.2	Bevel	1	-	-
004000	50 µL	50	25	0.5	0.2	Bevel	1	-	-
005000	100 µL	50	25	0.5	0.2	Bevel	1	-	-
006000	250 µL	50	25	0.5	0.2	Bevel	1	-	-
007000	500 µL	50	25	0.5	0.2	Bevel	1	-	-
Fixed needle, gas tight syringes									
002200	10 µL	50	26	0.47	0.11	Bevel	1	-	031810
002202	10 µL	50	26	0.47	0.11	Bevel	6	-	031810
002208	10 µL	70	26	0.47	0.11	Bevel	6	-	031810
003200	25 µL	50	25	0.5	0.2	Bevel	1	-	031815
004200	50 µL	50	25	0.5	0.2	Bevel	1	-	031820
005200	100 µL	50	25	0.5	0.2	Bevel	1	-	031825
006200	250 µL	50	25	0.5	0.2	Bevel	1	-	031830
007200	500 µL	50	25	0.5	0.2	Bevel	1	-	031835
008102	1 mL	50	22	0.72	0.37	Bevel	1	-	0318441
008502	2.5 mL	50	22	0.72	0.37	Bevel	1	-	031852
Fixed needle syringes with flexible plunger									
001100	5 µL	50	26	0.47	0.11	Bevel	1	-	-
002100	10 µL	50	26	0.47	0.11	Bevel	1	-	-
002105	10 µL	50	26	0.47	0.11	Cone	1	-	-
002130	10 µL	50	26	0.47	0.11	Bevel	6	-	-
002133	10 µL	50	26	0.47	0.11	Cone	6	-	-
002135	10 µL	50	23	0.63	0.11	Cone	6	-	-
Fixed needle syringes with guided plunger									
001400	5 µL	50	26	0.47	0.11	Bevel	1	-	-
002400	10 µL	50	26	0.47	0.11	Bevel	1	-	-

General purpose manual syringes continued

Syringe part number	Volume	Needle length (mm)	Needle gauge	Needle OD (mm)	Needle ID (mm)	Needle tip	Pack size	Replacement needle part number	Replacement plunger part number
Removable needle syringes									
001050	5 µL	50	26	0.47	0.11	Bevel	1	036110	-
002050	10 µL	50	26	0.47	0.11	Bevel	1	037110	-
002080	10 µL	50	26	0.47	0.11	Bevel	6	037110	-
002180*	10 µL	50	26	0.47	0.11	Bevel	6	037110	-
003050	25 µL	50	25	0.5	0.2	Bevel	1	038110	-
004050	50 µL	50	25	0.5	0.2	Bevel	1	038110	-
005050	100 µL	50	25	0.5	0.2	Bevel	1	038110	-
005055	100 µL	70	25	0.5	0.2	Bevel	1	038130	-
006050	250 µL	50	25	0.5	0.2	Bevel	1	038110	-
007050	500 µL	50	25	0.5	0.2	Bevel	1	038110	-
Removable needle, gas tight syringes									
002250	10 µL	50	26	0.47	0.11	Bevel	1	037110	031811
002252	10 µL	50	26	0.47	0.11	Bevel	6	037110	031811
003250	25 µL	50	25	0.5	0.2	Bevel	1	038110	031815
004250	50 µL	50	25	0.5	0.2	Bevel	1	038110	031820
005250	100 µL	50	25	0.5	0.2	Bevel	1	038110	031825
006250	250 µL	50	25	0.5	0.2	Bevel	1	038110	031830
007250	500 µL	50	25	0.5	0.2	Bevel	1	038110	031835
008100	1 mL	50	23	0.63	0.32	Bevel	1	039110	031842
008500	2.5 mL	50	23	0.63	0.32	Bevel	1	039110	031852
008700	5 mL	50	23	0.63	0.32	Bevel	1	031516	031856
008900	10 mL	50	23	0.63	0.32	Bevel	1	031516	031862
Removable needle, guided plunger syringes									
001450	5 µL	50	26	0.47	0.11	Bevel	1	036110	-
001495	5 µL (half scale)	50	26	0.47	0.11	Bevel	1	037110	-
002450	10 µL	50	26	0.47	0.11	Bevel	1	037110	-
002455	10 µL (GT)	50	26	0.47	0.11	Bevel	1	037110	031805
Removable needle, valve syringes									
004279	50 µL	50	23	0.63	0.2	Bevel	1	-	031820
005279	100 µL	50	23	0.63	0.2	Bevel	1	-	031825
006279	250 µL	50	23	0.63	0.2	Bevel	1	-	031830
007279	500 µL	50	23	0.63	0.2	Bevel	1	-	031835
008110	1 mL	50	23	0.63	0.2	Bevel	1	-	031842
008510	2.5 mL	50	23	0.63	0.2	Bevel	1	-	031852

*Denotes repeating adaptor.



SGE syringes | Luer Lock and Luer Tip

Product specifications and part numbers

Specifications			
Accuracy and reproducibility	Operator dependent	Scale length	50 μ L to 25 mL = 60 mm 50 mL = 84.2 mm 100 mL = 104 mm
Borosilicate glass barrel outer diameter (OD)	50 μ L to 500 μ L = 8 mm 1 mL = 9 mm 2.5 mL = 11 mm 5 mL = 14 mm 10 mL = 18 mm 25 mL = 27 mm 50 mL = 32.8 mm 100 mL = 40.8 mm	Thread in plunger stem	6-32 UNC
		International standards traceability	✓

Luer Lock and Luer Tip terminations offer universal connections for a number of different applications. This allows different needles or accessories to be connected quickly for workflows in analytical settings. This termination type can be used with a valve to enable samples to be easily stored and transported prior to analyses, from the field to the laboratory.



Luer Lock and Luer Tip syringes

Syringe part number	Volume	Pack size	Replacement plunger part number
Fixed, gas tight Luer Tip syringes			
004229	50 µL	1	031820
005229	100 µL	1	031825
006229	250 µL	1	031830
007229	500 µL	1	031835
008020	1 mL	1	031842
008420	2.5 mL	1	031852
Fixed, gas tight Luer Lock syringes			
004230	50 µL	1	031820
004232*	50 µL	1	-
005230	100 µL	1	031825
005232*	100 µL	1	-
006230	250 µL	1	031830
006232*	250 µL	1	-
007230	500 µL	1	031835
007232*	500 µL	1	-
008025	1 mL	1	0318441
008425	2.5 mL	1	031852
008762	5 mL	1	0318562
008962	10 mL	1	031864
009463	25 mL	1	031874
Removable, gas tight Luer Lock syringes			
008760	5 mL	1	031856
008960	10 mL	1	031862
009462	25 mL	1	031870
009660	50 mL	1	0312170
009760	100 mL	1	0312176
Removable, gas tight Luer Lock valve syringes			
008160	1 mL	1	031842
008560	2.5 mL	1	031852
008770	5 mL	1	031856
008970	10 mL	1	031862
009472	25 mL	1	031870
009670	50 mL	1	0312170
009770	100 mL	1	0312176

*Denotes plunger stop.



Hamilton cross reference

Variation notes:

F = fixed, N = needle, GT = gas tight, with PTFE tipped plunger,
LL = Luer Lock, LT = Luer Tip, OC = On-column, R = removable, WO = without

Hamilton part number	Part description and detail	Trajan part number	Volume	Termination	Needle length	Gauge	Needle tip	Equivalent or option	Variation
160310	1750 HITACHI SYRINGE	007660	500 µL	M10 GT	-	-	-	E	-
202640	701RSN AOC 14/17(22s/1.69"/2)	002898	10 µL	RN	42 mm	23	Cone	O	23 g needle
202660	1002LTN FN CTC SYR (22/56/5)	008631	2.5 mL	FN GT	56 mm	23	Side hole	O	23 g needle
202880	701RN VARIAN 8100/8200 (26s/57/5)	002924	10 µL	RN GT	53 mm	25	Side hole	O	25 g needle, 53 mm length
203043	1702N CTC SYRINGE (26s/51/AS)	003700	25 µL	FN GT	50 mm	26	Cone	O	26 g needle
203072	SYR,701 FN CTC,SLIM (26s/51/2)	002980	10 µL	FN	50 mm	26	Cone	O	26 g cone tipped needle
203073	701N FN CTC SYRINGE (22s/51/3)	002710	10 µL	FN	51 mm	22s	LC	E	-
203074	SYR,1702 FN CTC,SLIM (26s/51/AS)	0039871	25 µL	FN GT	50 mm	23	Cone	O	23 g needle
203075	1702N FN CTC SYRINGE (22s/51/3)	003715	25 µL	FN GT	51 mm	22s	LC	E	-
203076	SYR,1710 FN CTC,SLIM (26s/51/AS)	005700	100 µL	FN GT	50 mm	26	Cone	E	-
203077	SYR,1710N FN CTC,SLIM (22s/51/3)	005715	100 µL	FN GT	51 mm	22s	LC	E	-
203078	1725N FN CTC SYRINGE (26/51/AS)	006700	250 µL	FN GT	50 mm	26	Cone	E	-
203079	1725N CTC SYRINGE (22/51/LC)	LMK.2620821	250 µL	FN GT	51 mm	22	LC	E	-
203082	1001LTN CTC SYRINGE (23/56/5)	008131	1 mL	FN GT	56 mm	23	Side hole	E	-
203084	1002LTN CTC SYRINGE (23/56/5)	008631	2.5 mL	FN GT	56 mm	23	Side hole	E	-
203141	1001LTN CTC SYRINGE (26/56/5)	008136	1 mL	FN GT	56 mm	26	Side hole	E	-
203181	1002LTN CTC SYRINGE (26/56/5)	008636	2.5 mL	FN GT	56 mm	26	Side hole	E	-
203185	7701.2 CTC SYRINGE (26/51/AS)	000790	2.0 µL	RN	50 mm	23	Cone	O	2 µL instead of 1.2 µL
203189	75 FN CTC SYRINGE (26s/51/AS)	001982	5 µL	FN	50 mm	26	Cone	O	26 g needle
203194	1701N CTC SYRINGE (22s/51/3)	LMK.2606416	10 µL	FN	51 mm	22s	LC	E	-
203205	701 FN CTC SYRINGE (26s/51/AS)	002700	10 µL	FN	50 mm	26	Cone	O	26 g needle
203235	1710 FN CTC SYRINGE (22/51/3)	005720	100 µL	FN GT	51 mm	22	LC	E	-
203235	1710N CTC SYRINGE (22/51/3)	LMK.2620721	100 µL	FN GT	51 mm	22	LC	E	-
203274	1702N CTC SYRINGE (22s/51/3)	LMK.2620517	25 µL	FN GT	51 mm	22s	LC	E	-
203349	1750 FN CTC SYR (22/51/3)	007720	500 µL	FN GT	51 mm	22	LC	E	-
203361	701 FN CTC SYR (23S/51/AS)	002981	10 µL	FN	50 mm	23	Cone	O	23 g needle
203362	701 FN CTC SYR (23S-26S/51/AS)	002980	10 µL	FN	50 mm	26	Cone	O	26 g needle
203363	701 FN CTC SYR (23S/51/2)	002981	10 µL	FN	50 mm	23	Cone	O	23 g cone tipped needle
203566	1710 CTC A200S SYR (22s/51/3)	005331	100 µL	FN GT	51 mm	22s	LC	E	-
204000	SYRINGE,75N(26S/50/2)	0019821	5 µL	FN	50 mm	26	Cone	O	26 g cone tipped needle
204001	SYRINGE,701SN(26S/50/2)	0029801	10 µL	FN	50 mm	26	Cone	O	26 g cone tipped needle
204051	SYRINGE,75SN(26S/50/AS)	0019821	5 µL	FN	50 mm	26	Cone	O	26 g needle
204052	SYRINGE,701SN 26S/50/AS)	0029801	10 µL	FN	50 mm	26	Cone	O	26 g needle
204379	1705 CTC SYRINGE (22s/51/3)	LMK.2620617C	50 µL	FN GT	51 mm	22s	LC	E	-
204400	1710 CTC SYRINGE (22/51/LC)	LMK.2620721C	100 µL	FN GT	51 mm	22	LC	E	-
204452	1710 CTC SYRINGE (22s/51/LC)	LMK.2620719C	100 µL	FN GT	51 mm	22s	LC	E	-
204475	1702 CTC SYRINGE (22s/51/LC)	LMK.2620517C	25 µL	FN GT	51 mm	22s	LC	E	-
207189	701 FN PAL3 (26S/85/AS)	002867	10 µL	FN	85 mm	26	Cone	O	26 g needle
207290	1002 FN CTC PAL3 (23/65/5)HS	008655	2.5 mL	FN GT	65 mm	23	Side hole	E	-
207292	1010 RN CTC PAL3(19/57/3)	008951	10 mL	FN GT	57 mm	19	LC	E	-
207803	701 FN PAL3 (23S/57/AS)	002861	10 µL	FN	57 mm	23	Cone	O	23 g needle
207807	701 FN PAL3 (26S/57/AS)	002865	10 µL	FN	57 mm	26	Cone	O	26 g needle
207813	1701 RN PAL3 (22S/57/3)	002880	10 µL	FN GT	57 mm	22	LC	O	22 g needle

Hamilton part number	Part description and detail	Trajan part number	Volume	Termination	Needle length	Gauge	Needle tip	Equivalent or option	Variation
207826	1710 PAL3 (22s/57/LC)	LMK.3030908	100 µL	FN GT	57 mm	22s	LC	E	-
207829	1725 FN PAL3 (23/57/AS)	006862	250 µL	FN GT	57 mm	23	LC	E	-
207831	1725 FN PAL3 (26/85/AS)	006868	250 µL	FN GT	85 mm	26	LC	E	-
207832	1750 PAL3 (22/57/LC)	LMK.2616922	500 µL	FN GT	57 mm	22	LC	E	-
207836	1001 FN PAL3 (22/57/3)	008150	1 mL	FN GT	57 mm	22	LC	E	-
207837	1701 FN PAL3 (26S/57/AS)	002866	10 µL	FN GT	57 mm	26	Cone	O	26 g needle
207839	1701 FN PAL3 (23S/57/AS)	002862	10 µL	FN GT	57 mm	23	Cone	O	23 g needle
207840	1710 FN PAL3 (26S/57/AS)	005866	100 µL	FN GT	57 mm	26	Cone	O	26 g needle
207853	1001 FN CTC PAL3 (23/65/5)HS	008155	1 mL	FN GT	65 mm	23	Side hole	E	-
208311	1710 PAL3 (22/57/LC)	LMK.2616704C	100 µL	FN GT	57 mm	22	Cone	E	-
54658-01	SYRINGE,1710C,AUTO SAMPLER	005696	100 µL	GT	-	-	-	E	-
54659-01	SYRINGE,1725C,AUTO SAMPLER	006683	250 µL	GT	-	-	-	E	-
54660-01	SYRINGE,1750C,AUTO SAMPLER	007696	500 µL	GT	-	-	-	E	-
54661-01	SYRINGE,1001C,AUTO SAMPLER	008196	1 mL	GT	-	-	-	E	-
54662-01	SYRINGE,1002C,AUTO SAMPLER	008596	2.5 mL	GT	-	-	-	E	-
62161-01	SYRINGE,1702C,SPARK AUTO	003696	25 µL	GT	-	-	-	E	-
67430-01	SYR,1702N,(23/51/AS),CTC-S	003700	25 µL	FN GT	50 mm	26	Cone	O	26 g needle
67432-01	SYR,1710N,(22S/51/3),CTC-S-X	005331	100 µL	FN GT	51 mm	22	LC	O	22 g needle
67434-01	SYR,1710N,(23/51/AS),CTC-S	005335	100 µL	FN GT	50 mm	23	Cone	E	-
67436-01	SYR,75N,(26S/51/AS),CTC-S	0019821	5 µL	FN	50 mm	26	Cone	O	26 g needle
67438-01	SYR,701N,(26S/51/AS),CTC-S	0029801	10 µL	FN	50 mm	26	Cone	O	26 g needle
67440-01	SYR,701SN,(23S/51/AS),CTC-S	002951	10 µL	FN	50 mm	23	Cone	O	23 g needle
67442-01	SYR,1725N,(22/51/3),CTC-S	006720	250 µL	FN GT	51 mm	22	LC	E	-
67442-01	SYR,1725N,(22/51/3),CTC-S	LMK.2620821	250 µL	FN GT	51 mm	22	LC	E	-
67444-01	SYR,1701N,(22/51/3),CTC-S	LMK.2606416	10 µL	FN GT	51 mm	22s	LC	O	22s g needle
67446-01	SYR,1702N,(22S/51/3),CTC-S	003715	25 µL	FN GT	51 mm	22	LC	O	22 g needle
67446-01	SYR,1702N,(22S/51/3),CTC-S	LMK.2620517	25 µL	FN GT	51 mm	22	LC	O	22 g needle
67448-01	SYR,1750N,(22/51/3),CTC-S	007720	500 µL	FN GT	51 mm	22	LC	E	-
67450-01	SYR,1705N,(22/51/3),CTC-S	004810	50 µL	FN GT	51 mm	22	LC	E	-
67450-01	SYR,1705N,(22/51/3),CTC-S	LMK.2620615	50 µL	FN GT	51 mm	22	LC	E	-
67452-01	SYR,1710SN,(22S/51/3),CTC-S	005715	100 µL	FN GT	51 mm	22	LC	O	22 g needle
67452-01	SYR,1710SN,(22S/51/3),CTC-S	LMK.2620719	100 µL	FN GT	51 mm	22	LC	O	23 g needle
67454-01	SYR,1701SN,(23S/51/AS),CTC-S	0029871	10 µL	FN GT	50 mm	23	Cone	O	23 g needle
80000	1701N 10 µL SYR (26s/2"/2)	002200	10 µL	FN GT	50 mm	26	Bevel	O	26 g needle
80004	1701NCH 10 µL SYR (26s/2"/2)	002200 + 031930	10 µL	FN GT	50 mm	26	Bevel	O	26 g needle
80020	1702 WISP SYR 25 µL	003990	25 µL	GT	-	-	-	E	-
80024	1725 WISP SYR 250 µL	006690	250 µL	GT	-	-	-	E	-
80030	1701RN 10 µL SYR (26s/2"/2)	002250	10 µL	RN GT	50 mm	26	Bevel	O	26 g needle
80039	1701NPT5 FN 10 µL SYR (26s/2"/5)	002250 + 037410	10 µL	RN GT	50 mm	26	Side hole	O	26 g RN
80065	1701RNR 10 µL SYR (22s/2"/3)	002313	10 µL	RN GT	51 mm	22	LC	O	22 g needle
80074	SYRINGE,175ASN FN,23S GA,1.71	001810	5 µL	FN	42 mm	23	Cone	O	Not GT, full scale 5 µL instead of half scale 10 µL
80074	SYRINGE,175ASN FN,23S GA,1.71	002812	10 µL	FN GT	42 mm	23	Cone	O	Full scale 10 µL instead of half scale 5 µL
80075	1701N 10 µL SYR (26s/2"/3)	002335	10 µL	FN GT	51 mm	22	LC	O	22 g needle
80076	175ASN FN SYR (23-26/1.71"/HP)	001821	5 µL	FN	42 mm	23/26	Cone	O	Not GT, full scale 5 µL instead of half scale 10 µL
80076	175ASN FN SYR (23-26/1.71"/HP)	002826	10 µL	FN GT	42 mm	23/26	Cone	O	Full scale 10 µL instead of half scale 5 µL

Hamilton part number	Part description and detail	Trajan part number	Volume	Termination	Needle length	Gauge	Needle tip	Equivalent or option	Variation
80079	1701ASN SYR(23S/26S/1.71"/HP)	002826	10 µL	FN GT	42 mm	23/26	Cone	O	23/26 g needle
80080	1701ASN SYR (23s/1.71"/HP)	002812	10 µL	FN GT	42 mm	23	Cone	O	23 g needle
80084	175AS RN(23s/1.71"/HP)	002829	10 µL	RN GT	42 mm	23/26	Cone	O	Dual gauge needle, full scale 10 µL instead of half scale 5 µL
80085	1701N 10 µL SYR (26/2"/3)	002335	10 µL	FN GT	51 mm	22s	LC	O	22s g needle
80086	175AS RN SYR (23-26/1.71"/HP)	002829	10 µL	RN GT	42 mm	23/26	Cone	O	Full scale 10 µL instead of half scale 5 µL
80087	1701ASRN 10 µL SYR 23s/1.71"/HP	002829	10 µL	RN GT	42 mm	23/26	Cone	O	Dual gauge needle
80088	1701ASRN 10 µL SYR 26s/1.71"/HP	002829	10 µL	RN GT	42 mm	23/26	Cone	O	Dual gauge needle
80089	1701ASRN SYR (23S/26S/1.71"/HP)	002829	10 µL	RN GT	42 mm	23/26	Cone	O	23/26 g needle
80090	175ASN FN 5 µL (23S/1.71"/HP) 6/PK	002812	10 µL	FN GT	42 mm	23	Cone	O	Full scale 10 µL instead of half scale 5 µL
80090	175ASN FN 5 µL (23S/1.71"/HP) 6/PK	002816	10 µL	RN GT	42 mm	23	Cone	O	Full scale 10 µL instead of half scale 5 µL
80092	175ASN FN 5 µL (23-26/1.71"/HP) 6/PK	002827	10 µL	FN GT	42 mm	23/26	Cone	O	Full scale 10 µL instead of half scale 5 µL
80094	1701ASN SYR (23s/1.71"/HP) 6/PK	002812	10 µL	FN GT	42 mm	23	Cone	O	PK1
80094	1701ASN SYR (23s/1.71"/HP) 6/PK	002816	10 µL	FN GT	42 mm	23	Cone	O	PK1
80096	1701ASN (23-26/1.71"/HP) 6/PK	002827	10 µL	FN GT	42 mm	23/26	Cone	E	-
80100	7001KH 1 µL SYR (25/2.75"/3)	000570	1.0 µL	RN	70 mm	26	Cone	O	26 g cone tipped needle
80104	7001KHCH 1 µL SYR (25/2.75"/3)	000570 + 031930	1.0 µL	RN	70 mm	26	Cone	O	26 g cone tipped needle
80107	7001KHGW 1 µL SYR (25s/2.75"/3)	000570 + 031930	1.0 µL	RN	70 mm	26	Cone	O	26 g cone tipped needle
80135	7001KH 1.0 µL SYR (25/2.75"/2)	000506	1.0 µL	RN	70 mm	23	Cone	O	23 g needle
80175	7001ASRN (26/1.71"/HP)	000610	1.0 µL	RN	42 mm	23	Cone	O	23 g needle
80176	7001ASRN (23/1.71"/HP)	000610	1.0 µL	RN	42 mm	23	Cone	E	-
80200	1702N 25 µL SYR (22s/2"/2)	003200	25 µL	FN GT	50 mm	25	Bevel	O	25 g needle
80201	1702LT 25 µL SYR	004229	50 µL	F LT GT	-	-	-	O	50 µL
80222	1702TLX 25 µL SYR	004232	50 µL	F LL GT	-	-	-	O	50 µL
80223	1702TLX SYR W/BSHG STD BTN	004232	50 µL	F LL GT	-	-	-	O	50 µL, non-adjustable plunger stop
80230	1702RN 25 µL SYR (22s/2"/2)	003250	25 µL	RN GT	50 mm	25	Bevel	O	25 g needle
80238	1702RNW 25 µL SYR (25s/1.97"/3)	003250 + 038260	25 µL	RN GT	50 mm	25s	LC (Waters)	E	-
80239	1702NPT5 25 µL SYR (22s/2"/5)	003250 + 038410	25 µL	RN GT	50 mm	-	Side hole	O	25 g RN
80265	1702RNR 25 µL SYR (22s/2"/3)	003312	25 µL	RN GT	51 mm	22	LC	O	22 g needle
80275	1702N 25 µL SYR (22s/2"/3)	003300	25 µL	FN	51 mm	22	LC	O	Not GT, 22 g needle
80285	1702N 25 µL SYR (22/2"/3)	003300	25 µL	FN	51 mm	22	LC	O	Not GT
80300	701N 10 µL SYR (26s/2"/2)	002000	10 µL	FN	50 mm	26	Bevel	O	26 g needle
80300	701N 10 µL SYR (26s/2"/2)	002950	10 µL	FN	50 mm	26	Bevel	O	26 g needle
80304	701NCH 10 µL SYR (26s/2"/2)	002000 + 031930	10 µL	FN	50 mm	26	Bevel	O	26 g needle
80307	701NWX 10 µL SYR (26s/2"/2)	002000 + 031930	10 µL	FN	50 mm	26	Bevel	O	26 g needle
80318	701SN 10 µL SYR (26s/3.15"/AS)	0029921	10 µL	FN	80 mm	26	Cone	O	26 g needle

Hamilton part number	Part description and detail	Trajan part number	Volume	Termination	Needle length	Gauge	Needle tip	Equivalent or option	Variation
80330	701RN 10 µL SYR (26s/2"/2)	002050	10 µL	RN	50 mm	26	Bevel	O	26 g needle
80334	701RNCH 10 µL SYR (26s/2"/2)	002050 + 031930	10 µL	RN	50 mm	26	Bevel	O	26 g needle
80336	701RN 10 µL SYR 6/PK (26s/2"/2)	002080	10 µL	RN	50 mm	26	Bevel	O	26 g needle
80337	701RNWG 10 µL SYR (26s/2"/2)	002050 + 031930	10 µL	RN	50 mm	26	Bevel	O	26 g needle
80339	701NPT5 10 µL SYR (26s/2"/5)	002050 + 037410	10 µL	RN	50 mm	26	Side hole	O	26 g RN
80342	701SN 10 µL SYR (23s/2"/HP)	002005	10 µL	FN	50 mm	26	Cone	O	26 g needle
80350	701SN 10 µL SYR (26s/2.75"/2)	002003	10 µL	FN	70 mm	26	Bevel	O	26 g needle
80357	701ASRN 10 µL SYR (23s/1.71"/HP)	002815	10 µL	RN	42 mm	23	Cone	O	23 g needle
80358	701ASRN 10 µL SYR (26s/1.71"/HP)	002805	10 µL	RN	42 mm	26	Cone	O	26 g needle
80359	701ASRN 10 µL (23-26/1.71"/HP)	002829	10 µL	RN GT	42 mm	23/26	Cone	O	GT
80360	901N 10 µL SYR (26s/2"/2)	002400	10 µL	FN	50 mm	26	Bevel	O	26 g needle
80365	701SNR 10 µL SYR (22s/2"/3)	002301	10 µL	FN	51 mm	22s	LC	E	-
80366	701N 10 µL SYR 6/PK (26s/2"/2)	002030	10 µL	FN	50 mm	26	Bevel	O	26 g needle
80370	901RN 10 µL SYR (26s/2"/2)	002450	10 µL	RN	50 mm	26	Bevel	O	23 g needle
80383	701SN 10 µL SYR (26s/2"/3)	002301	10 µL	FN	51 mm	22s	LC	O	22s g needle
80384	701SN 10 µL SYR (26s/3"/2)	002003	10 µL	FN	70 mm	26	Bevel	O	70 mm needle
80387	701ASN 10 µL SYR (23s/1.71"/HP)	002810	10 µL	FN	42 mm	23	Cone	O	23 g needle
80388	701ASN 10 µL SYR (26s/1.71"/HP)	002800	10 µL	FN	42 mm	26	Cone	O	26 g needle
80389	701ASN 10 µL SYR-HP 26s (6/PK)	002804	10 µL	FN	42 mm	26	Cone	O	26 g needle
80390	701ASN 10 µL SYR-HP 23s (6/PK)	002814	10 µL	FN	42 mm	23	Cone	O	23 g needle
80391	701ASN 6/PK (23s-26s/1.71"/HP)	002822	10 µL	FN	42 mm	23/26	Cone	O	Dual gauge needle
80393	701ASN SYR (23s-26s/1.71"/HP)	002821	10 µL	FN	42 mm	23/26	Cone	O	Dual gauge needle
80398	701ASN 10 µL SYR (23S/1.71"/2)	002810	10 µL	FN	42 mm	23	Cone	O	23 g cone tipped needle
80399	701ASN 10 µL SYR (26S/1.71"/2)	002800	10 µL	FN	42 mm	26	Cone	O	26 g cone tipped needle
80400	702N 25 µL SYR (22s/2"/2)	003000	25 µL	FN	50 mm	25	Bevel	O	25 g needle
80404	702NCH FN 25 µL SYR (22s/2"/2)	003000 + 031930	25 µL	FN	50 mm	25	Bevel	O	25 g needle
80407	702NWG 25 µL SYR (22s/2"/2)	003000 + 031930	25 µL	FN	50 mm	25	Bevel	O	25 g needle
80419	702SN FN 25 µL SYR (22/2"/3)	003300	25 µL	FN	51 mm	22	LC	E	-
80430	702RN 25 µL SYR (22s/2"/2)	003050	25 µL	RN	50 mm	25	Bevel	O	25 g needle
80439	702NPT5 25 µL SYR (22s/2"/5)	003050 + 038410	25 µL	RN	50 mm	25	Side hole	O	25 g RN
80465	702SNR 25 µL SYR (22s/2"/3)	003300	25 µL	FN	51 mm	22	LC	E	-
80500	705N 50 µL SYR (22s/2"/2)	004000	50 µL	FN	50 mm	25	Bevel	O	25 g needle
80501	705LT 50 µL SYR	004229	50 µL	F LT GT	-	-	-	O	GT
80505	705NCH 50 µL SYR (22s/2"/2)	004000 + 031930	50 µL	FN	50 mm	25	Bevel	O	25 g needle
80521	705SN 50 µL SYR (22/2"/3)	004300	50 µL	FN	51 mm	22	LC	E	-
80530	705RN 50 µL SYR (22s/2"/2)	004050	50 µL	RN	50 mm	25	Bevel	O	25 g needle
80539	705NPT5 50 µL SYR (22s/2"/5)	004050 + 038410	50 µL	RN	50 mm	-	Side hole	O	25 g RN
80565	705SNR 50 µL SYR (22s/2"/3)	004300	50 µL	FN	51 mm	22	LC	O	22 g needle
80600	710N 100 µL SYR (22s/2"/2)	005000	100 µL	FN	50 mm	25	Bevel	O	25 g needle
80601	710LT 100 µL SYR	005229	100 µL	F LT GT	-	-	-	E	-
80605	710NCH 100 µL SYR (22s/2"/2)	005000 + 031930	100 µL	FN	50 mm	25	Bevel	O	25 g needle
80621	710SN 100 µL SYR (22/2"/3)	005300	100 µL	FN	51 mm	22	LC	E	-
80630	710RN 100 µL SYR (22s/2"/2)	005050	100 µL	RN	50 mm	25	Bevel	O	25 g needle
80639	710NPT5 100 µL SYR (22s/2"/5)	005050 + 038410	100 µL	RN	50 mm	25	Side hole	O	25 g RN
80665	710SNR 100 µL SYR (22s/2"/3)	005300	100 µL	FN	51 mm	22	LC	E	-
80700	725N 250 µL SYR (22S/2"/2)	006000	250 µL	FN	50 mm	25	Bevel	O	25 g needle

Hamilton part number	Part description and detail	Trajan part number	Volume	Termination	Needle length	Gauge	Needle tip	Equivalent or option	Variation
80701	725LT 250 µL SYR	006229	250 µL	F LT GT	-	-	-	O	GT
80730	725RN 250 µL SYR (22s/2"/2)	006050	250 µL	RN	50 mm	25	Bevel	O	25 g needle
80739	725N 250 µL SYR (22S/2"/5)	006050 + 038410	250 µL	RN	50 mm	25	Side hole	O	25 g RN
80765	725NR 250 µL (22/2"/3)	006300	250 µL	FN	51 mm	22	LC	E	-
80800	750N 500 µL SYR (22/2"/2)	007000	500 µL	FN	50 mm	25	Bevel	O	25 g needle
80801	750LT 500 µL SYR	007229	500 µL	F LT GT	-	-	-	O	GT
80830	750RN 500 µL SYR (22/2"/2)	007050	500 µL	RN	50 mm	25	Bevel	O	25 g needle
80839	750N 500 µL SYR (22/2"/5)	007050 + 038410	500 µL	RN	50 mm	25	Side hole	O	25 g RN
80865	750N 500 µL SYR (22/2"/3)	007300	500 µL	FN	51 mm	22	LC	E	-
80900	1705N 50 µL SYR (22s/2"/2)	004200	50 µL	FN	50 mm	25	Bevel	O	25 g needle
80901	1705LT 50 µL SYR	004229	50 µL	F LT GT	-	-	-	E	-
80920	1705TLL 50 µL SYR	004230	50 µL	F LL GT	-	-	-	E	-
80922	1705TLLX 50 µL SYR	004232	50 µL	F LL GT	-	-	-	E	-
80927	1705TLL 50 µL SYR W/SLOTS	004230	50 µL	F LL GT	-	-	-	E	-
80930	1705RN 50 µL SYR (22s/2"/2)	004250	50 µL	RN GT	50 mm	25	Bevel	O	25 g needle
80938	1705RNW 50 µL SYR(25s/1.97"/3)	004250 + 038260	50 µL	RN GT	50 mm	26	LC (Waters)	O	26 g needle
80939	1705NPT5 50 µL SYR (22s/2"/5)	004250 + 038410	50 µL	RN GT	50 mm	25	Side hole	O	25 g RN
80956	1705SL 50 µL SYR (22s/2"/2)	004279	50 µL	RN GT	50 mm	23	Cone	O	23 g cone tipped needle
80962	1705CX 50 µL SYR W/STOP	004995	50 µL	1/4-28 UNF	-	-	-	E	-
80965	1705RNR 50 µL SYR (22s/2"/3)	004312	50 µL	RN GT	51 mm	22	LC	O	22 g needle
80975	1705N 50 µL SYR (22s/2"/3)	004312	50 µL	RN GT	51 mm	22	LC	O	22 g RN
80985	1705N 50 µL SYR (22/2"/3)	004312	50 µL	RN GT	51 mm	22	LC	O	RN
81000	1710N 100 µL SYR (22s/2"/2)	005200	100 µL	FN	50 mm	25	Bevel	O	25 g needle
81001	1710LT 100 µL SYR	005229	100 µL	F LT GT	-	-	-	E	-
81020	1710TLL 100 µL SYR	005230	100 µL	F LL GT	-	-	-	E	-
81022	1710TLLX 100 µL SYR	005232	100 µL	F LL GT	-	-	-	E	-
81027	1710TLL 100 µL SYR W/SLOTS	005230	100 µL	F LL GT	-	-	-	E	-
81030	1710RN 100 µL SYR (22s/2"/2)	005250	100 µL	RN GT	50 mm	25	Bevel	O	25 g needle
81038	1710RNW 100 µL SYR (25s/1.97"/3)	005250 + 038260	100 µL	RN GT	50 mm	26s	LC (Waters)	O	26s g needle
81039	1710NPT5 100 µL SYR (22s/2"/5)	005250 + 038410	100 µL	RN GT	50 mm	25	Side hole	O	25 g RN
81056	1710SL 100 µL SYR (22s/2"/2)	005279	100 µL	RN GT	50 mm	23	Cone	O	23 g cone tipped needle
81060	1710C 100 µL SYR	005990	100 µL	1/4-28 UNF	-	-	-	O	With plunger stop
81062	1710CX 100 µL SYR W/STOP	005990	100 µL	1/4-28 UNF	-	-	-	E	-
81065	1710RNR 100 µL SYR (22s/2"/3)	005312	100 µL	RN GT	51 mm	22	LC	E	-
81075	1710N 100 µL SYR (22s/2"/3)	005312	100 µL	RN GT	51 mm	22	LC	O	22 g RN
81085	1710N 100 µL SYR (22/2"/3)	005312	100 µL	RN GT	51 mm	22	LC	O	RN
81100	1725LTN 250 µL SYR (22s/2"/2)	006200	250 µL	FN	50 mm	25	Bevel	O	Not LT, 25 g needle
81101	1725LT 250 µL SYR	006229	250 µL	F LT GT	-	-	-	E	-
81120	1725TLL 250 µL SYR	006230	250 µL	F LL GT	-	-	-	E	-
81122	1725TLLX 250 µL SYR	006232	250 µL	F LL GT	-	-	-	E	-
81127	1725TLL 250 µL SYR W/SLOTS	006230	250 µL	F LL GT	-	-	-	E	-
81130	1725RN 250 µL SYR (22s/2"/2)	006250	250 µL	RN GT	50 mm	25	Bevel	O	25 g needle
81138	1725RNW 250 µL SYR (25s/1.97"/3)	006250 + 038260	250 µL	RN GT	50 mm	25	LC (Waters)	E	-
81139	1725LTN 250 µL SYR (22S/2"/5)	006250 + 038410	250 µL	RN GT	50 mm	25	Side hole	O	Not LT, 25 g RN
81156	1725SL 250 µL SYR (22s/2"/2)	006279	250 µL	RN GT	50 mm	23	Cone	O	23 g needle
81162	1725CX 250 µL SYR W/STOP	006995	250 µL	1/4-28 UNF	-	-	-	E	-
81165	1725RNR 250 µL SYR (22/2"/3)	006312	250 µL	RN GT	51 mm	22	LC	E	-

Hamilton part number	Part description and detail	Trajan part number	Volume	Termination	Needle length	Gauge	Needle tip	Equivalent or option	Variation
81175	1725LTN 250 µL SYR (22S/2"/3)	006312	250 µL	RN GT	51 mm	22	LC	O	Not LT, 22 g RN
81185	1725LTN 250 µL SYR (22/2"/3)	006312	250 µL	RN GT	51 mm	22	LC	O	Not LT, RN
81201	1750LT 500 µL SYR	007229	500 µL	FN LT GT	-	-	-	E	-
81216	1750LTN 500 µL SYR (22/2"/3)	007312	500 µL	RN GT	51 mm	22	LC	O	Not LT, RN
81217	1750LTN 500 µL SYR (22/2"/2)	007200	500 µL	FN	50 mm	25	Bevel	O	Not LT, 25 g needle
81220	1750TLL 500 µL SYR	007230	500 µL	FN LL GT	-	-	-	E	-
81222	1750TLLX 500 µL SYR	007232	500 µL	FN LL GT	-	-	-	E	-
81227	1750TLL 500 µL SYR W/SLOTS	007230	500 µL	FN LL GT	-	-	-	E	-
81230	1750RN 500 µL SYR (22/2"/2)	007250	500 µL	RN GT	50 mm	25	Bevel	O	25 g needle
81243	1750LTNPT5 500 µL SYR (22/2"/5)	005250 + 038410	500 µL	RN GT	50 mm	25	Side hole	O	Not LT, 25 g needle
81256	1750SL 500uL SYR (22/2"/2)	007279	500 µL	RN GT	50 mm	23	Cone	O	23 g cone tipped needle
81262	1750CX 500 µL SYR W/STOP	007995	500 µL	1/4-28 UNF	-	-	-	E	-
81265	1750RNR 500 µL SYR (22/2"/3)	007312	500 µL	RN GT	51 mm	22	LC	E	-
81301	1001LT 1.0 mL SYR	008020	1 mL	F LT GT	-	-	-	E	-
81316	1001LTN 1.0 mL SYR (22/2"/3)	008105	1 mL	RN GT	51 mm	22	LC	O	RN
81317	1001LTN 1.0 mL SYR (22/2"/2)	008102	1 mL	FN GT	50 mm	22	Bevel	O	Not LT
81318	1001LTNCH 1.0 mL SYR (22/2"/2)	008102	1 mL	FN GT	50 mm	22	Bevel	O	Not LT, WO adaptor
81320	1001TLL 1.0 mL SYR	008025	1 mL	F LL GT	-	-	-	E	-
81324	1001TLLCH 1.0 mL SYR	008025	1 mL	F LL GT	-	-	-	O	WO adaptor
81327	1001TLL 1.0 mL SYR W/SLOTS	008025	1 mL	F LL GT	-	-	-	E	-
81330	1001RN 1.0 mL SYR (22/2"/2)	008100	1 mL	RN GT	50 mm	23	Bevel	O	23 g needle
81343	1001LTNPT5 1.0 mL SYR (22/2"/5)	008100 + 039120	1 mL	RN GT	50 mm	-	Side hole	O	Not LT, 23 g needle
81356	1001SL 1.0 mL SYR (22/2"/2)	008110	1 mL	RN GT	-	-	-	O	23 g needle
81360	1001C 1.0 mL SYR	008185	1 mL	1/4-28 UNF	-	-	-	-	-
81365	1001RNR 1.0 mL SYR (22/2"/3)	008105	1 mL	RN GT	51 mm	22	LC	E	-
81401	1002LT 2.5 mL SYR	008420	2.5 mL	F LT GT	-	-	-	E	-
81403	1002LTCH 2.5 mL SYR	008420	2.5 mL	F LT GT	-	-	-	O	WO adaptor
81416	1002LTN 2.5 mL SYR (22/2"/3)	008505	2.5 mL	RN GT	51 mm	22	LC	O	Not LT, RN
81417	1002LTN 2.5 mL SYR (22/2"/2)	008502	2.5 mL	FN GT	50 mm	22	Bevel	O	Not LT
81418	1002LTNCH 2.5 mL SYR (22/2"/2)	008502	2.5 mL	FN GT	50 mm	22	Bevel	O	WO adaptor
81420	1002TLL 2.5 mL SYR	008425	2.5 mL	FN LL GT	-	-	-	E	-
81424	1002TLLCH 2.5 mL SYR	008425	2.5 mL	FN LL GT	-	-	-	O	WO adaptor
81427	1002TLL 2.5 mL SYR W/SLOTS	008425	2.5 mL	F LL GT	-	-	-	E	-
81430	1002RN 2.5 mL SYR (22/2"/2)	008500	2.5 mL	RN GT	50 mm	23	Bevel	O	23 g needle
81443	1002LTNPT5 2.5 mL SYR (22/2"/5)	008500 + 039120	2.5 mL	RN GT	50 mm	23	Side hole	O	Not LT, 23 g FN
81456	1002SL 2.5 mL SYR (22/2"/2)	008510	2.5 mL	RN GT	-	23	-	O	23 g needle
81460	1002C 2.5 mL SYR	008687	2.5 mL	1/4-28 UNF	-	-	-	E	-
81501	1005LT 5.0 mL SYR	008760	5 mL	R LL GT	-	-	-	O	LL not LT
81516	1005LTN 5 mL SYR (22/2"/3)	008700 + 0315233	5 mL	RN GT	50 mm	22	LC	O	Not LT, RN
81517	1005LTN 5.0 mL SYR (22/2"/2)	008700	5 mL	RN GT	50 mm	23	Bevel	O	Not LT, 23 g needle
81518	1005LTNCH 5.0 mL SYR (22/2"/2)	008762	5 mL	F LL GT	-	-	-	O	Not LT, WO needle
81520	1005TLL 5.0 mL SYR	008762	5 mL	F LL GT	-	-	-	E	-
81524	1005TLLCH 5.0 mL SYR	008762	5 mL	F LL GT	-	-	-	O	WO adaptor
81527	1005TLL 5 mL SYR W/SLOTS	008762	5 mL	F LL GT	-	-	-	E	-
81530	1005RN 5.0 mL SYR (22/2"/2)	008700	5 mL	RN GT	50 mm	23	Bevel	O	23 g needle
81560	1005C 5.0 mL SYR	008787	5 mL	1/4-28 UNF	-	-	-	E	-
81601	1010LT 10.0 mL SYR	008962	10 mL	F LL GT	-	-	-	O	LL not LT
81610	1010W 10.0 mL (WATERS) SYR	008962	10 mL	F LL GT	-	-	-	E	-

Hamilton part number	Part description and detail	Trajan part number	Volume	Termination	Needle length	Gauge	Needle tip	Equivalent or option	Variation
81616	1010LTN 10 mL SYR (22/2"/3)	008900 + 0315233	10 mL	RN GT	50 mm	22	LC	O	Not LT, RN
81617	1010LTN 10.0 mL SYR (22/2"/2)	008900	10 mL	RN GT	50 mm	23	Bevel	O	RN
81618	1010LTNCH 10.0 mL SYR (22/2"/2)	008962	10 mL	F LL GT	-	-	-	O	LL not LT, WO adaptor
81620	1010TLL 10.0 mL SYR	008962	10 mL	F LL GT	-	-	-	E	-
81624	1010TLLCH 10.0 mL SYR	008962	10 mL	F LL GT	-	-	-	O	WO adaptor
81627	1010TLL 10 mL SYR W/SLOTS	008962	10 mL	F LL GT	-	-	-	E	-
81630	1010RN 10.0 mL SYR (22/2"/2)	008900	10 mL	RN GT	50 mm	23	Bevel	O	23 g needle
81660	1010C 10.0 mL SYR	008987	10 mL	1/4-28 UNF	-	-	-	E	-
82017	1001.25LTN 1.25 mL SYR (22/2"/2)	008502	2.5 mL	FN GT	50 mm	22	Bevel	O	Not LT, 2.5 mL instead of 1.25 mL
82520	1025TLL 25.0 mL SYR	009463	25 mL	F LL GT	-	-	-	E	-
82525	1025TLL W/O FL 25 mL SYR W/SLOT	009463	25 mL	F LL GT	-	-	-	O	-
82527	1025TLL 25 mL SYR W/SLOTS	009463	25 mL	F LL GT	-	-	-	E	-
84850	85N 5 µL SYR (26s/2"/2)	001400	5 µL	FN	50 mm	26	Bevel	O	26 g needle
84851	85RN 5 µL SYR (26s/2"/2)	001450	5 µL	RN	50 mm	26	Bevel	O	26 g needle
84852	801N 10 µL SYR (26s/2"/2)	002400	10 µL	FN	50 mm	26	Bevel	O	26 g needle
84853	801RN 10 µL SYR (26s/2"/2)	002450	10 µL	RN	50 mm	26	Bevel	O	26 g needle
85020	1050TLL 50.0 mL SYR	009660	50 mL	R LL GT	-	-	-	E	-
85027	1050TLL 50 mL SYR W/SLOTS	009660	50 mL	R LL GT	-	-	-	E	-
86020	1100TLL 100.0 mL SYR	009760	100 mL	R LL GT	-	-	-	E	-
86204	7101KHCH 1 µL SYR (22/2.75"/3)	000553	1.0 µL	RN	70 mm	23	Cone	O	23 g cone tipped needle
86207	7101KHWG 1 µL SYR (22/2.75"/3)	000553	1.0 µL	RN	70 mm	23	Cone	O	23 g cone tipped needle
86211	7101KH 1 µL SYR (22s/2.75"/2)	000506	1.0 µL	RN	70 mm	23	Bevel	O	23 g needle
86250	7000.5KH 0.5 µL SYR (25/2.75"/3)	000310	0.5 µL	RN	70 mm	23	Cone	O	23 g cone tipped needle
86252	7000.5KHCH .5 µL SYR(25/2.75/3)	000355	0.5 µL	RN	70 mm	23	Cone	O	23 g cone tipped needle
86254	7000.5KHWG .5 µL SYR(25/2.75/3)	000355	0.5 µL	RN	70 mm	23	Cone	O	23 g cone tipped needle
86259	7000.5KH 0.5 µL SYR (25/2.75"/2)	000311	0.5 µL	RN	70 mm	23	Bevel	O	23 g needle
86274	7000.5ASRN (26/1.71"/HP)	000400	0.5 µL	RN	42 mm	26	Cone	E	-
86276	7000.5ASRN (23/1.71"/HP)	000410	0.5 µL	RN	42 mm	23	Cone	E	-
86311	S0500 0.5L SYR (TLL)	009910	500 mL	F LL GT	-	-	-	E	-
86312	S1000 1.0L SYR (TLL)	009920	1 L	F LL GT	-	-	-	E	-
86313	S1500 1.5L SYR (TLL)	009930	2 L	F LL GT	-	-	-	O	2 L
86314	S2000 2.0L SYR (TLL)	009930	2 L	F LL GT	-	-	-	E	-
86326	1025SL 25 mL SYR (22/2"/2)	009472	25 mL	R LL GT	-	-	-	O	LL, WO needle
86336	1050SL 50 mL SYR (22/2"/2)	009670	50 mL	R LL GT	-	-	-	O	LL, WO needle
86346	1100SL 100 mL SYR (22/2"/2)	009770	100 mL	R LL GT	-	-	-	O	LL, WO needle
87402	701RNFS 10 µL SYR (0.17 mm/10 cm/3)	002050 + 037610	10 µL	RN	100 mm	-	OC	E	-
87404	1701RNFS 10 µL SYR (0.17 mm/10 cm/3)	002250 + 037610	10 µL	RN GT	50 mm	-	OC	E	-
87900	75N 5 µL SYR (26s/2"/2)	001000	5 µL	FN	50 mm	26	Bevel	O	26 g needle
87919	75N 5 µL SYR (26s/2"/3)	001301	5 µL	FN	51 mm	22s	LC	O	22 g needle
87930	75RN 5.0 µL SYR (26s/2"/2)	001050	5 µL	RN	50 mm	26	Bevel	O	26 g needle
87943	65RNR 5.0 µL SYR (22s/2"/3)	001450	5 µL	RN	50 mm	26	Bevel	O	26 g bevel tipped needle
87957	75ASRN 5 µL SYR (23s/1.71"/HP)	001810	5 µL	FN	42 mm	23	Cone	O	23 g FN
87958	75ASRN 5 µL SYR (26s/1.71"/HP)	001800	5 µL	FN	42 mm	26	Cone	O	26 g FN
87959	75ASRN SYR (23S/26S/1.71"/HP)	001821	5 µL	FN	42 mm	23/26	Cone	O	Dual gauge FN
87987	75ASN 5 µL SYR (23s/1.71 "/HP)	001810	5 µL	FN	42 mm	23	Cone	O	23 g needle

Hamilton part number	Part description and detail	Trajan part number	Volume	Termination	Needle length	Gauge	Needle tip	Equivalent or option	Variation
87988	75ASN 5 µL SYR (26s/1.71"/HP)	001800	5 µL	FN	42 mm	26	Cone	O	26 g needle
87989	75ASN 5 µL SYR(26s/1.71"/HP) 6PK	001804	5 µL	FN	42 mm	26	Cone	O	26 g needle
87990	75ASN 5 µL SYR(23s/1.71"/HP) 6PK	001814	5 µL	FN	42 mm	23	Cone	O	23 g needle
87991	75ASN 5 µL SYR (23s/1.71"/2)	001810	5 µL	FN	42 mm	23	Cone	O	23 g cone tipped needle
87992	75ASN 5 µL SYR (26s/1.71"/2)	001800	5 µL	FN	42 mm	26	Cone	O	26 g cone tipped needle
87993	75ASN 5 µL SYR (23-26/1.71"/HP)	001821	5 µL	FN	42 mm	23/26	Cone	E	-
87994	75ASN 5 µL 6/PK (23-26/1.71"/HP)	001822	5 µL	FN	42 mm	23/26	Cone	E	-
88000	7105KH 5.0 µL SYR (24/2.75"/3)	000802	5 µL	RN	70 mm	23	Cone	O	23 g cone tipped needle
88004	7105KHCH 5.0 µL SYR (24/2.75"/3)	000852	5 µL	RN	70 mm	23	Cone	O	23 g cone tipped needle
88007	7105KHWG 5.0 µL SYR (24/2.75"/3)	000852	5 µL	RN	70 mm	23	Cone	O	23 g cone tipped needle
88011	7105KH 5.0 µL SYR (24/2.75"/2)	000803	5 µL	RN	70 mm	23	Bevel	O	23 g needle
88035	75ASN/PE SYR 5 µL 0.63 mm OD	001954	5 µL	FN	70 mm	23	Cone	O	Cone tipped needle
88040	75ASN/PE SYR 5 µL 0.47 mm OD	001953	5 µL	FN	70 mm	26	Cone	O	Cone tipped needle

Every effort has been made to ensure the SGE and L-MARK branded equivalents and similar close options suggested here are suitable alternative products, however the appropriateness for individual applications must remain the responsibility of the user.



eVol XR syringes and accessories

Product specifications and part numbers

eVol syringes

eVol syringes are designed for use with the eVol XR digital analytical syringe.

Accuracy of eVol syringes

Syringe volume	1 mL	500 µL	100 µL	50 µL	5 µL
At 100% (uncalibrated)*	±0.7%	±0.7%	±0.7%	±1.0%	±1.0%
At 100% (calibrated)**	±0.2%	±0.2%	±0.2%	±0.2%	±0.2%
At 10% (calibrated)***	±0.5%	±0.5%	±0.5%	±0.5%	±1.0%

*Calibration factor of 1.0000 applied to handle.

**Syringe and handle calibrated at full volume.

***Syringe and handle calibrated at 10% of capacity. Accuracy based on the 10% dispensed volume closest to zero position.

Note: For best results when performing repeat dispense (one aspiration followed by multiple dispense steps) use a calibration factor of 1.0000.

Precision of eVol syringes

Syringe volume	1 mL	500 µL	100 µL	50 µL	5 µL
At 100%	±0.3%	±0.3%	±0.4%	±0.4%	±0.5%
At 10%	±0.6%	±0.6%	±0.7%	±0.8%	±1.0%

eVol and eVol MEPS syringes

Syringe part number	Volume	Needle length (mm)	Needle gauge	Needle OD (mm)	Needle ID (mm)	Needle tip	Pack size	Replacement needle part number	Replacement plunger part number
eVol gas tight syringes									
2910020	5 µL	50	26s	0.50	0.12	Bevel	1	036910	2910380
2910021	5 µL	-	-	-	-	-	1	-	2910380
2910022	50 µL	50	25	0.50	0.20	Bevel	1	038110	2910382
2910023	50 µL	-	-	-	-	-	1	-	2910382
2910024	500 µL	50	23	0.63	0.32	Bevel	1	039110	2910384
2910025	500 µL	-	-	-	-	-	1	-	2910384
2910029	100 µL	50	25	0.50	0.20	Bevel	1	038110	2910383
2910035	1 mL	50	23	0.63	0.32	Bevel	1	039110	2910385
2910037	100 µL	-	-	-	-	-	1	-	2910383
2910320	5 µL	50	26s	0.50	0.12	Bevel	3	036910	2910380
2910322	50 µL	50	25	0.50	0.20	Bevel	3	038110	2910382
2910324	500 µL	50	23	0.63	0.32	Bevel	3	039110	2910384
2910329	100 µL	50	25	0.50	0.20	Bevel	3	038110	2910383
2910335	1 mL	50	23	0.63	0.32	Bevel	3	039110	2910385
eVol MEPS gas tight syringes									
2910026	500 µL	-	-	-	-	-	1	-	2910384
2910027	50 µL	-	-	-	-	-	6	-	2910382
2910028	100 µL	-	-	-	-	-	6	-	2910383

eVol XR accessories

Part number	Part description and detail
eVol accessories	
2910010	eVol stand (acrylic)
2910012	eVol charger
2910030	eVol charging stand
2910040	eVol replacement battery

MEPS

MEPS is microextraction by packed sorbent, the miniaturization of conventional SPE (solid phase extraction) packed bed devices from milliliter bed volumes to microliter volumes.

The MEPS approach to sample preparation is suitable for reversed phase, normal phase, mixed mode or ion exchange chemistries.

MEPS advantages over conventional SPE:

Less sample required giving you greater flexibility when you have small sample quantities.

- Less solvent used means less solvent waste and ultimately reduced expense.
- Faster preparation time, reducing from hours to minutes for improved laboratory workflow.

MEPS incorporates packed phase in a micro-cartridge or BIN (barrel insert and needle) which is then integrated into an SGE analytical syringe to make miniaturized SPE possible. With MEPS, the sample processing, extraction and injection steps are performed using the same syringe.

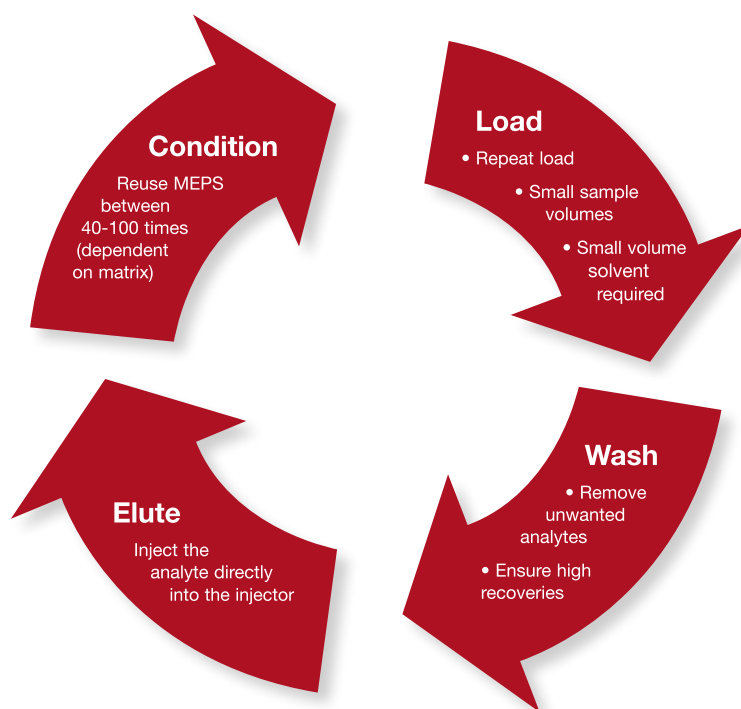

Configuration for MEPS

MEPS BINs are available for use with eVol MEPS syringes, with a range of packing material phases.

- MEPS BINs can be used with 50 μ L, 100 μ L and 500 μ L eVol MEPS syringes.
- LC needles are 55.5 mm in length, 22 gauge and LC tipped.
- GC needles are 55.5 mm in length, 23 gauge and cone tipped.

MEPS BINs

Part number	MEPS phase	Needle length (mm)	Needle gauge	Needle OD (mm)	Needle ID (mm)	Needle tip	Pack size
MEPS barrel insert and needle (BIN) for LC applications							
2900701	C18	55.5	22	0.72	0.17	LC	5
2900702	C8	55.5	22	0.72	0.17	LC	5
2900703	APS	55.5	22	0.72	0.17	LC	5
2900705	HVDB	55.5	22	0.72	0.17	LC	5
2900706	SDVB	55.5	22	0.72	0.17	LC	5
2900707	C2	55.5	22	0.72	0.17	LC	5
MEPS barrel insert and needle (BIN) for GC applications							
2900711	C18	55.5	23	0.63	0.14	Cone	5
2900712	C8	55.5	23	0.63	0.14	Cone	5
2900713	APS	55.5	23	0.63	0.14	Cone	5
2900715	HVDB	55.5	23	0.63	0.14	Cone	5
2900716	SDVB	55.5	23	0.63	0.14	Cone	5
2900717	C2	55.5	23	0.63	0.14	Cone	5

Notes

A series of horizontal dotted lines for writing notes.

For more information about this product
visit www.trajanscimed.com or contact
techsupport@trajanscimed.com

Specifications are subject to change without notice.

*Analytical syringes manufactured by Trajan Scientific and Medical
are intended for analytical and laboratory use only and are not intended
or approved for use with food, including the production or packaging
of food, nor medical or human in-vivo use.*

*Agilent is a registered trademark of Agilent Technologies, Inc.
Bruker is a registered trademark of Bruker Corporation.
PerkinElmer is a registered trademark of PerkinElmer, Inc.
Shimadzu is a registered trademark of Shimadzu Corporation.
Thermo Scientific is a registered trademark of Thermo Fisher Scientific, Inc.*

Syringes for the laboratory



BR-0519-G_Rev1 © Trajan Scientific Australia Pty Ltd 08/2023